



Moto G⁷ Power

en-us

© 2019 Motorola Mobility LLC. All rights reserved.

MOTOROLA, the stylized M logo, MOTO, and the MOTO family of marks are trademarks or registered trademarks of Motorola Trademark Holdings, LLC. LENOVO is a trademark of Lenovo. Google, Android, Google Play and other marks are trademarks of Google LLC. microSD Logo is a trademark of SD-3C, LLC. All other product or service names are the property of their respective owners.

Certain features, services and applications are network dependent and may not be available in all areas; additional terms, conditions and/or charges may apply. Contact your service provider for details.

All features, functionality, and other product specifications, as well as the information contained in this help content, are based upon the latest available information and believed to be accurate at the time of release. Motorola reserves the right to change or modify any information or specifications without notice or obligation.

Some images in help content are examples only.

Contents

Set up phone	1
Insert and remove SIM and SD cards	1
Manage dual SIMs	2
Add or remove accounts	4
Set up voicemail	5
Set up email	6
Make it yours	7
Accessibility settings	8
Visual assistance	8
Hearing assistance	10
Dexterity assistance	11
Use accessibility shortcuts	12
Learn the basics	14
Hardware diagram	14
About your home screen	15
About your lock screen	17
New to Android?	18
If this is your first smartphone	18
If you had an iPhone	20
About your Google account	21
Status bar icons	21
Phone terms you should know	26
Get around	29
Learn gestures	29
Use navigation bar	31
View notifications	32
Use voice commands	33
Use quick settings	34
Wake or put screen to sleep	37
Adjust volume	37
Turn flashlight on and off	39
Work with text	40
Use onscreen keyboard	40
Adjust keyboard vibrations	41

Cut, copy, paste text	42
Use voice typing	43
Fill in forms automatically	43
Get turn-by-turn directions	44
Take screenshots	44
Personalize your phone	46
Home screen	46
Change wallpaper	46
Customize your Favorites tray	46
Add widgets, shortcuts, or folders	47
Remove widgets, shortcuts, or folders	49
Use Time and Weather widget	50
Remake your home screen with launchers	51
Lock screen	53
Use a screen saver	53
Set screen lock	54
Add message to lock screen	56
Sounds	57
Set ringtones	57
Avoid interruptions with Do Not Disturb	58
Silence power on sound	60
Stop phone from speaking	61
Turn off charging sounds	61
Apps	62
About your apps	62
Use two apps at once	66
Manage your apps	68
Install or update apps	68
Manage or delete apps	70
Protect against harmful apps	72
Pin your screen	73
Search and web browser	75
Search the web	75
Search your phone	77
Use camera to scan and search	78

Browse websites	79
Text messaging	81
About text and multimedia messages	81
Read, send, manage text messages	82
Add attachments	84
Save attachments from text message	85
Turn group messaging on or off	85
Change default messaging app	86
Control notifications for text messages	86
Change text message reply to incoming calls	86
Get text messages on your computer	87
Email	89
Read, send, manage emails	89
View email attachments	91
Preview inboxes from home screen	91
Add email signature	92
Control email notifications	92
Calendar app	93
About the calendar	93
Find calendar events	93
Create and manage events	94
Control notifications for calendar events	95
Clock app	96
Set alarms	96
Use timer or stopwatch	97
Set date and time	98
Moto app	100
About the Moto app	100
Shrink screen for one-handed use	100
Preview notifications when screen sleeps	101
Photos app	104
Share photos and videos	104
Upload photos and videos	104
Calls, contacts, voicemail	106
Phone calls	106
Answer calls	106

Make calls	107
During a call	109
Make video calls	110
Make conference calls	110
Block calls and SMS	110
Turn on call waiting	112
View and delete call history	113
Contacts	115
Add contacts	115
Edit or delete contacts	116
Star your favorite contacts	117
Sort contacts	117
Share contacts	118
Voicemail	120
Use voicemail	120
Send all calls from contact to voicemail	121
Music	122
Listen to radio	122
Listen to music	123
Transfer music files	125
Connect a MIDI device	126
Battery	127
Charge phone	127
Extend battery life	127
Use Battery Saver mode	129
Storage	130
About storage options	130
Manage phone storage	131
Manage SD card	132
Find downloaded files	133
Recover recently deleted files	134
Upload music to cloud	134
Upload photos and videos	135
Scan documents and make copies	136

Network and internet	138
Connect with Wi-Fi	138
Use Airplane mode	139
Control data usage	139
Share your internet connection	141
Connect to VPNs	144
Connected devices	145
Connect with Bluetooth™	145
Tap & pay with NFC	147
Share or receive with NFC	148
Cast your screen to TV	149
Transfer files between phone and computer (USB)	150
Print from your phone	151
About wireless sharing	153
Other settings	156
Apps & notifications	156
Change app settings	156
Manage notifications	157
Turn emergency alerts off/on	159
Display	160
Stop automatic rotation	160
Adjust screen colors at night	160
Adjust screen brightness	161
Change font and display size	161
Change background color	161
Change screen timeout	161
Security & location	163
About security	163
Protect against harmful apps	164
Set up lost phone features	164
Lock and unlock phone	165
Set screen lock	165
Unlock with trusted devices	167
Unlock with your face	168

Unlock at trusted places	169
Keep phone unlocked while it's on you	170
Unlock with voice commands	171
Use fingerprint security	172
Use location services	174
Lock SIM card	175
Accounts	176
Add or remove accounts	176
Sync accounts and apps	177
Manage your personal information	178
System	180
Set up emergency information	180
Record your IMEI number	180
Find legal and product information	180
Use multiple languages	181
Users and guests	182
Share your phone	182
Add, modify, remove users	183
Add or delete guest	184
Fix a problem	185
Hardware issues	185
Phone is slow or unstable	185
Phone feels warm or hot	185
Phone won't turn on	186
Phone restarts or crashes	187
Screen is frozen or won't respond	188
Call and SIM issues	189
Problems making/receiving calls	189
Problems during calls	191
Battery issues	194
Charging problems	194
Battery drains too fast	194
Bluetooth, Wi-Fi, USB issues	196
Bluetooth problems	196
Wi-Fi problems	198
Can't transfer files or connect to computer	199

Account and sign-in issues	201
Forgot unlock code	201
Can't sign in to Google	201
Account sync issues	201
App issues	203
App or widget problems	203
Messaging problems	204
Camera problems	206
Maintenance procedures	208
Update Android software	208
Reset Wi-Fi, cellular data, and Bluetooth	208
Reset phone	209
Get more help	211

Insert and remove SIM and SD cards

Replace SIM or SD card

1. If you are removing an SD card, [unmount it](#) first ([Settings](#) > [Storage](#)).
2. Insert the tool into the hole in the tray and gently push to pop it out.

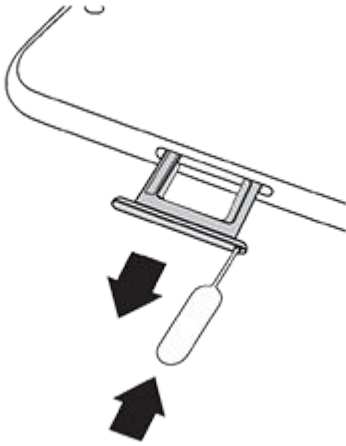

3. Insert or remove the cards as needed.

To use an SD card:

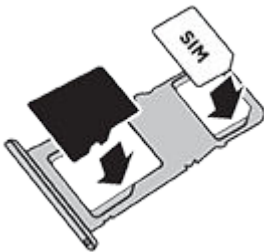

To use [two SIM cards](#) (dual-SIM models only):

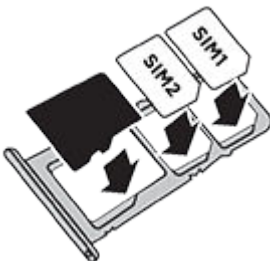

4. Push the tray back into the phone.

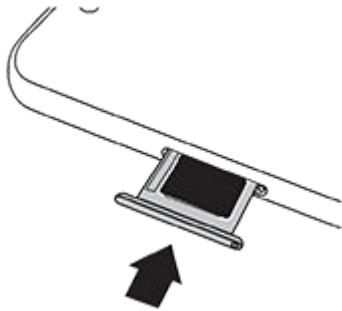

Format SD card

You'll need to choose one of two formats for your SD card: portable or extended internal. [Need help deciding which format to use?](#)

Portable storage

When you insert an SD card, it's automatically set to be portable storage for media files, letting you easily [swap the card](#) and its content between devices.

Be sure to set your storage location within media apps, like Camera and [Play Music](#) .

Extended internal storage

Instead of using it as portable storage, you can set your SD card to be internal storage, extending your device storage for large applications, games, and their data.

To format your SD card as internal storage:

1. Touch the SD card notification for the card you inserted.
2. Touch  > **Storage settings** > **Format as internal**.



[Learn more](#) about managing your SD card.

Manage dual SIMs

This information applies only to phones that support dual SIM cards and have both cards inserted.

About dual SIMs

When two SIMs are [inserted](#):

- You see  at the top of the home screen. If you see , [troubleshoot](#) the issue.
- Both SIMs can make and receive calls and text messages.
- Only the [owner](#) of the phone (not additional users or guests) can access dual SIM settings.

Set up SIM profile

Set SIM options based on how you expect to use the cards:

1. Go to **Settings** > **Network & internet** > **SIM cards**.
2. Select the option that best meets your needs:
 - **Smart SIM**: Automatically select SIM for voice calls based on your call history. In Brazil, selection is also based on your contact's carrier.
 - **Personal and Work**: Use one SIM for personal and the other for work-related voice calls.
 - **Manual**: Choose which SIM to use for voice calls, for data, and for SMS.
3. Follow onscreen instructions to complete setup.

Change SIM profile

1. Go to **Settings** > **Network & internet** > **SIM cards**.
2. Touch **Dual SIM usage profile**.
3. Select a different profile and touch **CHANGE PROFILE**.
4. Select a new profile.
5. Follow onscreen instructions to complete setup.

To keep the same profile but adjust options for data, SMS, voice calls, video calls, or contacts:

1. Go to **Settings** > **Network & internet** > **SIM cards**.
2. Touch each preferred SIM and contact option to change.

Change SIM name, color, ringtone

When two SIMs are inserted, you'll see them referenced in apps like Contacts, Messages, and Phone. The SIM name shows your carrier and, if you're using the Personal and Work profile, shows which it's assigned to, but you can rename it. You can also change SIM icon color to make them easy to differentiate.

1. Go to **Settings** > **Network & internet** > **SIM cards**.
2. Touch the SIM to change.
3. Change settings as needed:
 - To rename a SIM, touch **SIM name**, then type a new name.
 - To change icon color, touch **Color**, then touch a color.
 - To change the SIM's ringtone, touch **Phone ringtone**, then select a ringtone.

Add or remove accounts

About accounts

When you set up your phone, you were prompted to add a Google account. If you skipped this, be sure to set one up now so you can download apps from Play Store, get a customized information feed, and take full advantage of the Calendar, Gmail, and other apps included with [your account](#).

You can also add other web accounts.

For each account, you can control which of its features and apps [sync](#) with your phone.

Add Google account

To add a [Google account](#):

1. Go to [Settings](#) .
2. Touch **Accounts > Add account**.
3. Touch **Google** and follow the onscreen instructions to add an existing account or to create a new one.
4. Once the account is added, [Calendar](#) , [Contacts](#) , and other account features and apps are updated with information from that account. You can review and change what [syncs](#) with your phone for that account.

Tip: Keep your apps [up-to-date](#). To see if newer versions of the apps associated with your Google account are available, open the Play Store app and touch  > **My apps & games**.

Add non-Google account

You can add corporate email accounts, personal email accounts, or other accounts. Many social networking accounts are automatically set up when you install the app.

1. Go to [Settings](#) .
2. Touch **Accounts > Add account**.
3. Do one of the following:
 - Touch the type of account to add and follow the onscreen instructions. [Learn more](#) about setting up email accounts.
 - If you don't see the type of account you want to add, [install](#) the related app from Play Store, then sign into your account through the app.

4. Once the account is added, account-related features and apps are updated with information from that account. To review and change what **syncs** with your phone, touch the account type, then account name.

Remove account

If you remove an account, information you **synced** will be removed from your phone, but it is not deleted from your account.

To remove other accounts:

1. Go to **Settings** > **Accounts**.
2. Touch the account name.
3. Touch **Remove account**.



Tip: If you have trouble removing a corporate account, go to **Settings** > **Security & location** > **Device admin apps** and remove the checkmark for the account, then try to remove it again.

Set up voicemail



Set mailbox greeting

Your carrier provides and manages your voicemail.

To set your greeting:

1. Touch  > .
2. Touch & hold  to dial into your mailbox.
3. Follow your carrier's system prompts. If your voicemail is not set up, contact your carrier for instructions.

Change voicemail options

1. Touch  >  > **Settings**.
(If you don't see , swipe down on the screen.)
2. Touch **Voicemail**.
3. Touch **Advanced Settings**.
4. Change any of the options:

- To change voicemail service from your provider to another voicemail service or app, touch **Service**.
- To change the number dialed to access voicemail, touch **Setup**.

Set up email

Set up personal email

You can add multiple email accounts of the following types:

- Gmail
- Personal email from other providers (IMAP/POP)

If you [added](#) a Google account on your phone:

- When you open the Gmail app for the first time, you'll see your email for that account. You're already set up.
- To set up additional accounts, open Gmail and touch  > **Settings** > **Add account**.

If you didn't add a Google account to your phone and want to set up email for an IMAP/POP provider (an address that's not Gmail):

1. [Open](#) the **Gmail** app.
2. Follow the onscreen instructions to enter your email address, password, and account options.



If you have problems setting up the account, read Google's [help for Gmail](#) .

Set up corporate email

If you use Microsoft Office Outlook on your work computer, your phone can synchronize emails, calendar events, and contacts with the Microsoft Exchange server. Before you start, you'll need the following information from your company's IT department:

- Email address
- Email password
- Domain name
- Username
- Server name
- Security type/SSL settings
- Client certificate requirement

To set up corporate email:

1. [Open](#) the **Gmail** app.
2. Do one of the following:
 - If this is your first time opening the Gmail app, touch **Add an email address**.
 - If you have been using Gmail with another account, touch , then next to your account name, touch  > **Add account**.
3. Touch **Exchange and Office 365**.
4. Follow the onscreen instructions to enter your email address, password, and other information from your company's IT department.

Make it yours

Now that you're up and running (battery charged, contacts imported, accounts added), it's time for fun:

- Set the [wallpaper](#).
- Assign [ringtones](#) or [photos](#) to friends you call.
- Find some [games](#).
- Play some [music](#).

To protect your phone, be sure to:

- Set up a [screen lock](#).
- Set up [fingerprint security](#) to unlock your screen safely and quickly with a touch.
- In case you ever lose your phone, set up [Find My Device](#) and record your [IMEI number](#).

You'll probably also want to:

- Set up your [Bluetooth](#) and [Wi-Fi](#) connections.
- If you use [multiple languages](#), set them up so they appear on your keyboard.
- Set your schedule for [Do Not Disturb](#), to automatically silence your phone when you don't want to be interrupted.

Tip: If you've forgotten your new number, go to [Settings](#) > **System** > **About phone** > **Phone number**.

Visual assistance

Adjust colors if you're color blind

1. Go to [Settings](#) > **Accessibility**.
2. Touch **Color correction** and turn it on .
3. Touch **Correction mode** and choose an option.



How you see colors	Option to choose
It's difficult to tell violet from blue. Yellow and green appear redder.	Deuteranomaly (red-green)
Colors aren't bright. Red, orange, and yellow appear greener.	Protanomaly (red-green)
It's difficult to tell yellow and red from pink. Blue appears greener.	Tritanomaly (blue-yellow)

Color correction is an experimental feature and might not work correctly everywhere on your phone.



Use magnification gestures and icon

You can magnify the screen by triple tapping it or by touching  by the [navigation buttons](#).

To enable these gestures and add the icon:

1. Go to [Settings](#) > **Accessibility** > **Magnification**.
2. Adjust settings as needed:
 - To use gestures to zoom in and out, touch **Magnify with triple-tap** and turn it on .
 - To add , touch **Magnify with button** and turn it on .

Then, use these gestures:

- To zoom in/out, touch  or triple-tap the screen.
- To zoom temporarily, touch , then touch & hold anywhere on the screen. Drag to move around the screen, then lift your finger to zoom out.
- To scroll while zoomed in, drag two fingers across the screen.

- To adjust the zoom, pinch fingers together or apart.

You can't zoom in on the keyboard or the  buttons.

Tip: You can also adjust [font and display size](#).

Hear or feel when you touch the screen

1. Go to [Settings](#) > **Sound** > **Advanced**.
2. Do any of the following:
 - To hear a tone when you dial a number, turn on **Dial pad tones**.
 - To hear a click when you lock or unlock the screen, turn on **Screen locking sounds**.
 - To hear a click when you touch something on the screen, turn on **Touch sounds**.
 - To feel a vibration when you type on the keyboard, turn on **Touch vibration**.
 - To hear a tone when your phone starts, turn on **Power on sounds**.

Hear notification sounds

You can [assign a ringtone](#) for notifications from specific apps.

You can also control sounds used to notify you of other events:

1. Go to [Settings](#) > **Sound** > **Advanced**.
2. To hear when your phone begins charging and reaches a full charge, turn **Charging sounds** on .

Use TalkBack to read screens

Hear descriptions of everything you touch.

To enable TalkBack:

1. Go to [Settings](#) > **Accessibility**.
2. Touch **TalkBack** and turn it on.
3. Touch **Settings** and set the options you want.

Tip: To quickly turn TalkBack on/off, set up the [accessibility shortcut](#).

When TalkBack is on:

- Touch an item. Your phone speaks the name.

- Start typing. Your phone speaks each number or letter.
- Drag status bar down. Your phone speaks all of the notifications.
- Open a message, file, or book. Your phone reads the text out loud.

To control TalkBack volume:

- Press a Volume button to open volume settings, then use the  slider to adjust the level.
- Or, during voice readout, repeatedly press the Volume up or down buttons.

Tip: To learn about navigating with Explore by touch, go to **Settings > Accessibility > TalkBack > Settings > Help & Feedback**.

To silence readout and turn off TalkBack:

1. Swipe down and right on the screen.
2. Touch **Pause feedback**, then touch it again twice.
3. Touch **OK** twice.
4. Go to **Settings > Accessibility**.
5. Touch **TalkBack** and turn it off.

More assistance

You can also:

- Use [voice commands](#)
- [Dictate text](#) for messages

Hearing assistance



Turn on video captions

1. Go to **Settings > Accessibility**.
2. Touch **Captions** and turn captions on .
3. Specify options (language, text size, and style) for closed captioning.

Use hearing aids

To improve compatibility with hearing aids and reduce sound feedback:



1. Touch .

2. Touch  > **Settings** > **Accessibility**.
3. Turn **Hearing aids** on .

Set up TTY device

For text-based communication, you can use [text messaging](#) and [email](#).

If you prefer to connect to a TTY device:

1. Touch .
2. Touch  > **Settings** > **Accessibility** > **TTY mode**.
3. Select a mode:
 - **TTY Full**: Type and read text on your TTY device.
 - **TTY HCO**: Type text on your TTY and listen to voice replies on your phone.
 - **TTY VCO**: Speak into your phone and read text replies on your TTY.
4. Connect your phone and TTY with the audio cord that came with your TTY. Use the USB-C adapter that came with your phone.

Dexterity assistance

External switch or keyboard

If you're unable to use a touchscreen, Switch Access lets you control the phone using external switches or keyboard keys to select items, scroll, enter text, and more.

To use Switch Access, you must have one of the following:

- **An external switch.** USB or Bluetooth switch devices send keystroke signals to your phone.
- **An external keyboard.** Standard USB or Bluetooth keyboards can work as switch devices by assigning one or more keys to actions.

Connect the external device to your phone using the manufacturer's instructions. [Learn more](#) about connecting with Bluetooth.

Set up Switch Access

1. Go to [Settings](#) > **Accessibility**.
2. Touch **Switch Access** > **Settings**.
3. Touch **Open setup guide**.

4. Follow onscreen instructions to select:

- Number of switches
- Scanning options
- Switch assignments

To adjust Switch Access later:

1. Go to **Settings** > **Accessibility**.
2. Touch **Switch Access** > **Settings**.
3. Adjust options.

Use Switch Access

- To start scanning and highlighting items on the screen, press the assigned switch or key.
- To select a highlighted item, press the assigned switch or key, then press the switch or key assigned to select options.

Use accessibility shortcuts

Use accessibility menu

Get quick access to an accessibility menu that gives you better control of your phone.

To add the icon:

1. Go to **Settings** > **Accessibility**.
2. Touch **Accessibility Menu**.
3. Turn **Use service** on .

To use the menu:

1. At the bottom of the screen, touch .



If you've set other [accessibility tools](#) to use this icon, touch & hold it to switch between tools.

2. Choose an option from the menu.

Use Volume to control accessibility feature

You can use the Volume buttons to turn an accessibility feature of your choice ([TalkBack](#) , [Switch Access](#)) on or off.

To enable the shortcut:

1. Go to **Settings** > **Accessibility**.
2. Touch **Volume key shortcut** and turn it on .
3. To change the accessibility feature associated with the shortcut, touch **Shortcut service**.
4. To use the Volume buttons from the lock screen, turn **Allow from lock screen** on .

To use the shortcut:

Press and hold the Volume Up and Down buttons at the same time for three seconds.

You'll hear confirmation that the feature has been turned on or off.

Hardware diagram



1. Microphone
2. Headset jack
3. Front camera
4. Earpiece/speaker
5. Proximity sensor
6. Volume up/down button
7. Power button
8. Tray for SIM and SD card



1. Back camera
2. LED flash
3. Fingerprint sensor
4. USB-C/Charger
5. Microphone

About your home screen





You see the home screen when you turn on and unlock your phone or touch .



You can add more pages to the right as needed. To add a page, drag an app shortcut or widget to the edge of an existing page and place it on the new page.

Swipe right or left to move between pages.

Here are the parts of your home screen:



1. Status bar: Displays the time and [icons](#) that tell you about your phone's battery and network connections. Swipe down to see your [notifications](#) and [quick settings](#).
2. Widget: You can add [widgets](#) to your home screen for quick access to information or frequent tasks.
3. Shortcut: You can add shortcuts to open [apps](#) or [web pages](#) you use frequently.
4. App list: Swipe  up from the bottom of the screen to see the list of all your apps.
5. Favorites tray: Provides one touch access to your most-used apps from any home screen page. You can [customize](#) which apps appear here. To open the list of [all your apps](#), swipe up from the bottom of the home screen.
6. Navigation:
 -  takes you back one screen.
 -  returns you to the home screen from any app.
 -  lets you [switch](#) between recent apps.
 -  lets you open an accessibility menu. Appears after you [enable accessibility settings](#).

Note: If you're using the navigation bar, the    icons are hidden. To restore these icons, [turn off](#) the navigation bar.

7. Folder: Add [folders](#) to organize app shortcuts.

If you want an entirely new look and feel for your home screen, you can use a [different launcher](#). For a less drastic renovation, just [change the wallpaper](#).



About your lock screen

The lock screen appears when you're using a [screen lock](#) and you turn on or [wake](#) your phone.



Tip: If you're using [Moto Display](#), you'll see those notifications before you get to your lock screen.

From the lock screen, you can:

- **View and respond to notifications.** Double touch one to open it.
- **Open your quick settings.** Swipe down from top of screen.
- **Start a voice search.** Swipe  right.
- **Open the camera.** Swipe  left.
- **Go into Lockdown.** Temporarily turn off notifications and fingerprint unlocking.

You can customize your lock screen to:

- Control which [notifications](#), if any, appear.
- Add your [name](#) or a short message.

If this is your first smartphone

Welcome to the world of smartphones! Prepare to be impressed with all the ways you can organize and stay connected to the people and things most important to you. Check out these tips for a smooth start.

Learn the basics

Your smartphone is, after all, a phone for [making](#) and [answering](#) calls. But it also has a [keyboard](#) for sending [texts](#) and [emails](#) and a camera for taking photos and videos.

The status bar on your [home screen](#) displays the time and [icons](#) that tell you about your phone's battery and network connections.

Get apps

Your smartphone comes with many [fun and useful apps](#), but you can really unlock its power by [installing](#) apps that suit your lifestyle. Go to Play Store to explore free and paid apps that help you be more productive, organized, informed, in touch, and entertained.

Play Store also offers music, movies, TV shows, and books.

Protect your phone

You carry your phone around with you, and accidents happen; phones get lost sometimes. So set up some [security](#) and prevent heartache if you and your phone become separated.

Set up a screen lock. This is your first line of defense in keeping your sensitive information safe. Prefer numbers, shapes, words? Set up a PIN, pattern, or password required to unlock your phone.



A screen lock doesn't prevent you from immediately answering a call or accessing your camera.

Display your owner info. On your lock screen, you can discreetly display a “please return” message with some of your contact info so that, if your phone is lost, someone can return it to you.

Enable lost phone features. For peace of mind, check out [Find My Device](#) , in case you ever need to remotely locate and lock or erase your phone.

Personalize your phone

While changing your [wallpaper](#) is probably your first [customization](#), don't stop there. Be sure to explore your [Settings](#) to set ringtones, font sizes, data usage preferences, keyboard preferences, and much more. It's a great way to learn many of your phone's capabilities while customizing it to suit your needs.

In most apps you can touch  or  for app-specific settings. Be sure to see what options are available to you there, too.

Manage cellular data

Understand your data usage. Keep an eye on your data usage and learn how to make the most of it. See which apps use large amounts of data and adjust their settings if you want. You can stop [auto-syncing](#) over your carrier's network from quick settings by toggling the data connection off.

Use Wi-Fi to conserve cellular data. When you connect to a Wi-Fi network, your data will auto-sync over its connection instead of your carrier's network, saving cellular data for when you need it. From quick settings, toggle the Wi-Fi connection on.

Useful to know

Tell your phone what to do. Use your phone hands-free with voice commands. Tell it to navigate you, and listen to it speak the directions to you as you drive--it'll even reroute you if you've gone off course. Tell it to set alarms, find information on the web, make calls. Dictate instead of typing text.

Never miss a photo opportunity. Automatically open the camera right from your lock screen. Just twist your phone twice. Or, swipe  left. You can [automatically back up](#) your photos and videos with your Google account or with other photo sharing apps available from [Play Store](#) .

Store your stuff. Save your internal storage for apps by using an [SD card](#) to store photos, videos, and music. You can open stored items in associated apps, like Photos to see your photos and videos. It's simple to move items stored on your phone to a [computer](#) using the USB cable packaged with your phone.

For even more storage space, plus the ability to access your media and files from any internet connected device (phone, computer, tablet), your new phone gives you access to cloud storage. Your [Google account](#) provides you free cloud storage on Drive, which has its own app and is also available from the  menu throughout other apps.

When you know you'll have a weak connection or no connection, many of your apps let you pin cloud items, temporarily storing them on your phone. You can unpin when you're done to keep phone memory free.

Wi-Fi hotspot. You can share your phone's data connection as a Wi-Fi hotspot or directly tether your phone to a computer for internet access. If you have other devices that need an internet connection (for example, a laptop, tablet, or other phone), you can use your phone as a Wi-Fi hotspot.

Reboot phone. In the unlikely event that your phone becomes unresponsive, frozen, shows blank or black screen, or does not respond to the Power button, you can reboot it. Press and hold the Power button for 7 - 10 seconds. The phone will restart normally.

Certain features, services, and applications are network or carrier dependent and may not be available in all areas.

If you had an iPhone

Welcome to Android! Here are some differences between your old iPhone and your new phone.

Your assistant: You've retired Siri. Now, find info and get things done with Google Assistant. Just [set up](#) "OK, Google". Then ask for info or help with everyday tasks.

Apps:

- Goodbye Apple App Store, hello Google Play Store. [Play Store](#) is now your default app store. Apps aren't compatible between iPhone and Android. However, many developers make iPhone and Android versions of their apps; if the app stores your data online, then you can switch with little effort. Just download the Android version from Play Store and log in.
- Install apps remotely. On a computer, visit play.google.com. Browse apps on the bigger screen and then install them on your phone from your computer.

Your home screen:

- On your old iPhone, your home screen was far left. Now, you start with one [home screen](#) and can add more pages to the right as needed.
- Your old phone showed all apps on your home screen. With your new phone, you can put [shortcuts](#) to your most important apps on your home screen for easy access. Or, find your [full list](#) by swiping up from your [favorites tray](#). This frees up room on your home screen for widgets, making your new home much more lively.
- Android and iPhone both have app icons, but Android also has [widgets](#). Widgets are like mini apps on your home screen that are interactive or stream information to you. For example, widgets can provide weather updates or upcoming calendar events.
- Like your old iPhone, you'll see [notifications](#) at the top of the screen, which you can swipe down to review. But on your new phone, you can swipe them left or right to dismiss them.

Quick access to settings: On your old iPhone, to adjust settings you opened a Settings app. You can still do that. But now you've also got [quick settings](#). Swipe down from the top of the screen for easy access to toggles for [airplane mode](#), [Wi-Fi](#), and other frequently-used settings.

In the cloud: Your [Google account](#) is your key to cloud storage with Google. If you migrated your contacts to your phone, then you can see them from any device or computer by logging into Gmail. Your Google account includes apps like Calendar and Drive that let you work well with others. And it has apps that let you play too - access your photos, videos, music from any device when you log in with your Google account. Use Play Music to [upload](#) your iTunes library.

About your Google account

Benefits of your account

When you set up your phone, you [added](#) a Google account. If you haven't had a Google account before, this is more than just a password you set up for your phone.

A Google account lets you organize and access your personal information and files from any computer or mobile device:

- **Synchronize everything.** Never lose your contacts. Associate them with your Google account if you [create](#) them on your phone, and view them from Gmail on any computer or by signing into your Google account on any phone. Create [emails](#) or [calendar events](#) on your phone and view them on any computer. Access your [browser bookmarks](#) from any device.
- **Store in the cloud.** Upload your [photos](#), [videos](#), and [music](#) to the cloud; get to all of it without taking up space on your phone.
- **Keep your stuff secure.** Your account password secures it all and lets you access it from anywhere.

Maintaining your account

Other than remembering your password, you don't need to do much maintenance on your Google account - just enjoy the benefits of your secure, synchronized information. However, you can:

- Control how frequently your phone [syncs](#) your information.
- Review and [manage](#) the information Google collects from you, such as search and browsing history.

Learn about Google apps

Many Google apps, like [Gmail](#) , [Chrome](#) , [Photos](#) , and [Maps](#) are pre-loaded on your phone. To learn about and download additional Google apps, read [Google's information](#).

Can't sign in to Google account

If you're having problems signing in to your account, read [Google's support information](#).

Status bar icons

About status icons

The [status bar](#) at the top of the home screen contains icons that help you monitor your phone.

- **On the left**, icons tell you about apps, such as new messages or downloads. If you don't know what one of these icons means, swipe the status bar down for details.
- **On the right**, icons tell you about your phone's battery level and network connections.

A dot means there are more icons to view. Drag down from the top of the screen to see all icons.

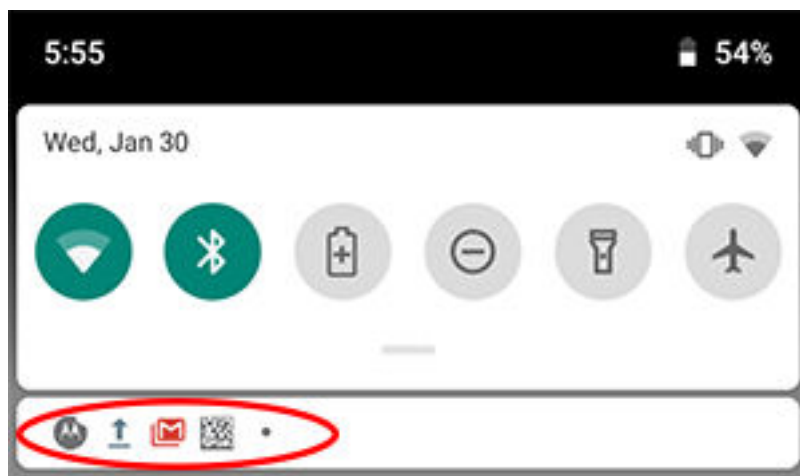





What status icons mean

These are the icons from apps that came on your phone and the phone status icons.

Icon	Meaning
CALLS	
	Active call.
	Missed call.
	Speakerphone on.
	Microphone muted.

NETWORK

 Connected to cellular/mobile network (full signal). Speed of your network connection is also shown. For example,  or . Possible speeds, from slowest to fastest, are 1X, 2G, 3G, H, H+, 4G. Available speeds depend on your carrier and your location.

 Poor connection to cellular/mobile network.

 Connected to different cellular/mobile network (roaming).

 [Data Saver](#) is on, preventing apps from using background data.

 Wi-Fi network within range.

 [Connected](#) to Wi-Fi network.

 Poor connection to Wi-Fi network.

 [No SIM card](#).

 Location services are in use.

 [Airplane mode on](#).

CONNECTIVITY

 [Bluetooth on](#).

 [Trusted device](#) connected.

 Your phone is a [Wi-Fi hotspot](#). Devices can connect to share your data connection.

 [Wireless display](#) or adaptor connected.

 Connected by [USB cable](#).

 [USB tethering](#) enabled.

 [NFC](#) enabled. Only some versions of this phone, sold in certain countries, support this feature.

SYNC AND UPDATES

 App updates are available for [download](#) from Play Store.

 App successfully installed from Play Store.

 Email and calendar sync in progress.

 Upload complete.

 Download complete.

 Google [backup](#) in progress.



 Google backup complete.

SOUND





 Vibrate.

 Song playing.



DO NOT DISTURB

-
-  [Do Not Disturb](#) mode is set to Total silence. Your phone does not ring for incoming calls or notifications.
 -  [Do Not Disturb](#) mode is set to Alarms only or Priority.
-



BATTERY

-
-  Battery fully charged.
 -  Battery charging.
 -  Battery low.
 -  Phone is in [Battery Saver mode](#).
-

ALARM AND CALENDAR

-
-  [Alarm](#) set.
 -  Upcoming [calendar](#) event.
-

EMAIL AND MESSAGING

-
-  [New email](#).
 -  [New Gmail message](#).
 -  [New text message](#).
-



New voicemail.



Important alert.

OTHER ICONS



Screenshot is available.

Apps that you [download](#) might show other icons to alert you about their status.

Certain features, services, and applications are network or carrier dependent and may not be available in all areas.

Phone terms you should know

Airplane mode. A [mode](#) allowing access to a device's non-wireless functions (e.g., music, games, etc.), while disabling its wireless radio functions that are banned on airplanes during flight.

app. Software that you can download for added functionality, such as games, email apps, bar code scanners and more. Some apps are already on your phone, and more can be downloaded from your phone's app store.

Bluetooth™. A short-range wireless technology you can use to connect a device to other nearby Bluetooth-capable devices and accessories, such as headsets, speakers, printers, etc. Use Bluetooth to make handsfree calls on a headset or in your car, listen to music on wireless speakers, use a wireless mouse or keyboard, or print a document in another room. [Set up Bluetooth.](#)

cellular network or mobile network. A network of radio-transmitting towers. You make calls on your phone using radio waves sent between the phone and the network towers. You also send data and access the Internet on this network. Carriers use different technologies to handle these radio transmissions (GSM, CDMA, Edge, 3G, 4G, LTE, HSPA, iDEN).

data. Information sent or received from your phone other than calls and text messages. You may use data when you access the internet, check your email, play games, use apps and more. Background tasks, such as syncing or location services, may also use data.

data usage. The amount of data your phone uploads or downloads over a network in a given period. Your phone uses your carrier's cellular network or over a Wi-Fi network. Depending on your plan with your carrier, you may be charged additional fees when your data usage exceeds your plan's monthly limits.

GPS. Global Positioning System. A global satellite-based system for determining precise locations on Earth. With GPS, your phone becomes your navigator when you're driving and your concierge when you're looking for a nearby meal, movie, or cup of coffee.

mobile hotspot. A device or app that lets you share your mobile data connection with multiple devices via Wi-Fi. You can connect different devices to your hotspot, including notebooks, netbooks, MP3 players, cameras, Smartphones, and portable gaming systems. The number of devices that can connect at one time depends on your carrier and connection speed.

NFC. Near-field communication. A wireless technology that transfers information between two compatible devices. Tap the devices together to share web addresses, contact info, apps, GPS locations and more.

notification. An alert from your phone or an app on your phone. Your phone displays icons in the status bar to notify you of new messages, calendar events and alarms. Icons can also indicate ongoing status, such as connection to a Wi-Fi network.

Play Store. Google's store where you can download apps, books, movies, and music. Choose from an assortment of free books or apps; purchase from an even larger selection.

SD card. Secure Digital (SD) card. A small, high-capacity removable memory card used in small, portable devices such as mobile phones, tablets, and digital cameras.

short cut. An icon you can add to your home screen that lets you quickly open an app. Create short cuts for apps you use frequently.

SIM card. Subscriber Identity Module (SIM) card. A card that securely stores information your carrier uses to authenticate your phone on the cellular network.

software update. An update to your phone's operating system that typically includes new features and fixes reported problems. The update is wirelessly downloaded to your phone at no additional cost to you.

status bar. Thin bar at the top of your [home screen](#) that displays the time and icons that tell you about your phone's battery and network connections. Apps display [icons](#) in the status bar to alert you of events, such as new messages.

sync. The process of sharing the same information across multiple devices and websites. Contacts, calendars and email are often synced through cloud services, so you can enter information on one device and access it through another.

Visual Voice Mail. An app that lets you see a list of your voice mail messages and manage them without having to dial into the traditional voice mail system. You can listen to, reply to, erase, and archive your messages. You can also call back, text, and add new contacts.

widget. An element you can add to your home screen that gives you quick access to information or frequent tasks. For example, widgets can provide weather updates, upcoming calendar events. Many are preinstalled on your phone. Apps you [download](#) may also include widgets.

Wi-Fi. A short-range wireless technology that provides a high-speed internet connection to wireless data devices. Many locations offer Wi-Fi connections, including airports, hotels,

restaurants and more. Using a Wi-Fi connection instead of your cellular network can help reduce your cellular data usage. Some public Wi-Fi connections may not be secure. You should only connect to those you trust and use some form of internet security on your devices. [Set up Wi-Fi](#).

Certain features, services, and applications are network or carrier dependent and may not be available in all areas.

Learn gestures

Gesture	Description
Touch	<p>Press with one finger and lift.</p> <p>Result: Open something (app or email) or choose something (checkbox, icon). It's like clicking a mouse on a computer.</p>
Touch & hold	<p>Press and wait before lifting one finger.</p> <p>Result: Select something (app icon, text on a page) and see possible actions.</p> <p>Try it: Touch & hold text on this page to see the copy feature.</p>
Drag	<p>Touch & hold an item and then, without lifting, slide your finger until you reach the target position.</p> <p>Result: Move elements on the screen; for example, change a toggle from ON to OFF.</p> <p>Try it: Drag an app shortcut or widget from one spot on your home screen to another.</p>
Swipe	<p>Quickly move one finger across the screen, without pausing when you first touch (so you don't drag instead).</p> <p>Result: Switch between home screens or between tabs in an app. Or, move quickly through a list.</p> <p>Try it: Open the Phone app and swipe left/right to switch between tabs.</p>
Pinch out to zoom	<p>Put two fingers on the screen and then drag them apart.</p> <p>Result: Zoom in to see larger version of photos and maps. Or, open expandable notifications.</p> <p>Try it: Open a photo and pinch out to zoom in on an area.</p>



Tip: If you have visual impairments, you can enable additional [magnification gestures](#).

Pinch in to zoom

Put two fingers on the screen, far apart, and then drag them together.

Result: Zoom out to see smaller version of photos or maps. Or, close expandable notifications.



More gestures: The [Moto](#) app includes additional actions for controlling your phone, which you can turn on/off.

Use navigation bar

Show navigation bar

Remove the ◀️🕒📦 navigation icons and use the — navigation bar instead.



1. [Open](#) the **Moto** app.
2. Touch ≡ > **Moto Actions**.
3. Touch **One Button Nav** and turn it on .

The navigation bar appears at the bottom of the screen.

To remove the navigation bar and restore the ◀️🕒📦 navigation icons, turn **One Button Nav** off .

Navigate with one finger

Use these gestures with the navigation bar to move between screens.

Gesture	Navigation
Touch	Go home 🕒
Touch & hold	Open Google Assistant
Swipe left	Go back ◀️
Swipe right	Switch between two most recent apps
Swipe up	See recent apps. Swipe up again for all apps.

Customize navigation gestures

You can change how your phone responds when you swipe the sensor:

1. [Open](#) the **Moto** app.
2. Touch \equiv > **Moto Actions** > **One Button Nav.**
3. Touch ∇ .
4. Select **Swipe left to go back** or **Swipe left to switch apps**.

View notifications

Find your notifications

Notifications alert you about things like new messages, calendar events, and alarms.

You see notifications:

- On your [lock screen](#)
- When you swipe the [status bar](#) down on any screen

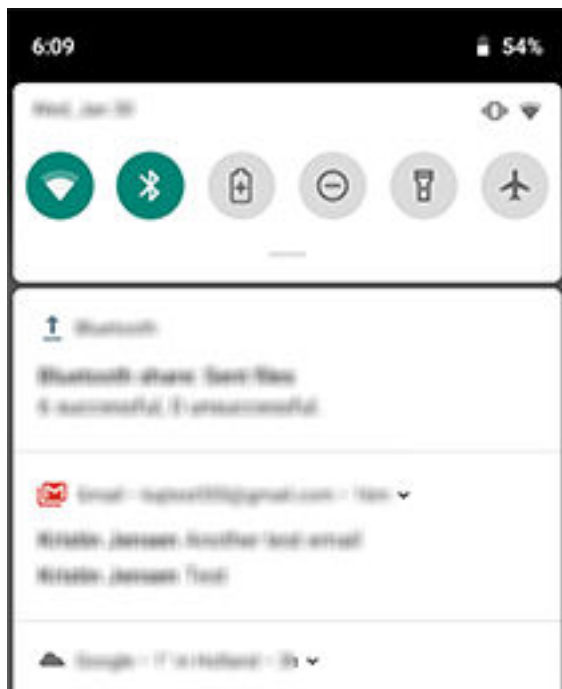



- When you touch & hold an app icon that shows a notification dot



If you receive multiple notifications from an app, they're bundled together. Swipe down to view more details.

Some important notifications pop up briefly over your current app so that you can take action. For example, a notification for an incoming call might appear while you're watching a video, so that you can answer or dismiss the call.

What you can do with notifications

- **Respond from a notification.** Many notifications include actions at the bottom that let you complete common tasks without opening the full app. If you have several notifications, these actions are hidden. When you see , touch it to reveal actions.
- **Open the app that sent the notification** Swipe down from the top of the screen and touch the notification to open the app. From your lock screen, touch the notification twice and enter your PIN, pattern, or password to unlock your screen and open the app.
- **Snooze a notification.** Swipe left or right slowly. Then touch  and select a duration to snooze notifications.
- **Dismiss a notification.** Swipe it sideways.
- **Clear all notifications.** Swipe to the end of your notifications and touch **CLEAR ALL**. Some notifications, like voicemails, require an action and cannot be dismissed.

Control your notifications



Use [Do Not Disturb](#) to silence all notifications when you don't want interruptions.

You can also [customize notifications](#), controlling the notification sound, which apps send notifications, how notifications show on your lock screen.

Use voice commands

Not all languages support voice commands.

Train launch phrase

1. [Open](#) the Google app, then touch  > **Settings** > **Voice** > **Voice Match**.
2. Turn on **Access with Voice Match** and follow the onscreen instructions to record your voice.
3. To unlock your phone when you say "OK, Google", turn **Unlock with Voice Match** on .

Speak a command

Tell your phone to call people, get directions, send messages, set alarms. The possibilities are enormous.

1. From the home screen or when you've started a search, say "OK, Google."
2. When the phone responds, say the command (for example, "Call Elise" or "Set alarm for 7 AM tomorrow").

Tip: To see a list of commands, say "Help."

3. Some commands cause your phone to speak a response to you. To stop the phone from speaking, touch .

Unlock screen automatically

You can set your phone to automatically unlock and perform all voice commands when:

- The phone recognizes your [voice](#) speaking "OK, Google"
- The phone is paired with a [trusted device](#), like a Bluetooth headset
- You're in a [trusted place](#), like home or work
- The phone recognizes your [face](#)
- The phone is in your [hand or bag](#)

Fix a problem

If your phone isn't recognizing "OK, Google" commands:

1. [Open](#) the Google app.
2. Touch  > **Settings** > **Voice**.
3. Touch **Voice Match** > **Retrain voice model**.

Use quick settings

Open quick settings

Settings you adjust frequently, like Wi-Fi and Bluetooth, are "quick settings", easy to get to from any screen.

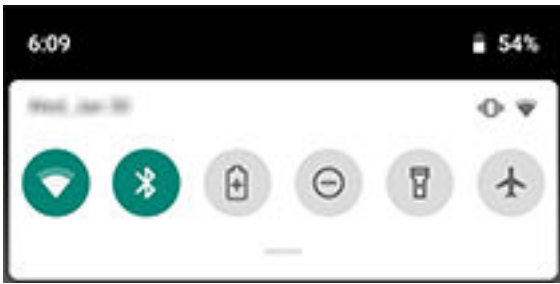

To see your first few quick settings, swipe down once from the top of your screen.



To see all quick settings, swipe down again.

Adjust quick settings

Do one of the following:

- **Touch** an icon to toggle the setting on  or off .
- **Touch & hold** an icon to adjust related settings.

Icon Setting



Wi-Fi



Bluetooth



Do Not Disturb



Flashlight



Auto-rotate



Battery Saver



Mobile data



Airplane mode



Cast your screen



Background data usage. Appears after you turn on Data Saver the first time.



Dim your screen at night. Appears after you turn on Night Light the first time.



Wi-Fi hotspot. Appears after you turn on hotspot the first time.





Brightness



SIM card

Open all settings

To open the full list of all settings, do one of the following:

- Open quick settings and touch .
- Or, open the  **Settings** app.

Tip: You can search the Settings app to find what you need quickly. Just touch  at the top of the app and type your search term.

Customize quick settings

You can rearrange quick settings, putting your most used at the top. You can also add or remove them.

1. Open quick settings.
2. Touch .
3. Drag to add or remove one.

To return quick settings to its original state, touch  > **Reset**.

Tip: You can also [change the background color](#) to be light or dark.

Wake or put screen to sleep

To save battery power, your screen automatically goes to sleep if you haven't used it for a while. You can [adjust](#) the amount of time before your screen should sleep.

To wake sleeping screen:

- Press the Power button. If you've set up a [screen lock](#), you need to unlock it.
- If you've added your [fingerprint](#) to the phone, touch the sensor to wake and unlock your phone.
- Your screen automatically wakes when you have an incoming call.

To put screen to sleep:

- Briefly press the Power button. When you set down your phone, it's good habit to do this. You save a bit of battery and keep it secure with the [screen lock](#).
- To keep your screen off and phone quiet when you don't want interruptions, like at night, use [Do Not Disturb](#) settings.

Adjust volume

Volumes you can control

Your phone has independent settings for these volumes:

- Call
- Media (music, video, games)
- [Alarm](#)
- Ringtone for incoming calls and notifications

Adjusting one volume won't affect the others, so you can crank up the tunes without making incoming callers sound like they're shouting.

Turn volume up or down





When you're on a call, press the [Volume buttons](#) to adjust the volume level of the other person on the call.

When you're not on a call, press the Volume buttons to adjust the media volume.

To adjust other volumes at any time:

1. Press a Volume button.
2. Touch .



3. Slide the volume levels where you want them:

Level	Sounds affected
	Music, videos, games, and other media
	Volume of the other person on a call
	Phone calls, notifications
	Alarm

Tip: To silence notifications and allow phone calls to ring, go to [Settings](#) > **Sound** > **Advanced** > **Default notification sound** and select **None**.

Silence ringing phone



Press the Power or Volume Down button.

Or, pick up your phone to silence it and switch to vibrate. (To enable, open the **Moto** app, touch  > **Moto Actions** > **Pick up to silence** and turn it on .)

Prevent phone from ringing

- To quickly switch to vibrate, press & hold the Power + Volume Up buttons until you feel a vibration and see .

Want to silence your phone instead of vibrating? Go to [Settings](#) > **System** > **Gestures**. Touch **Prevent ringing** > **Press Power & Volume Up together** > **Mute**.

- To switch to silent  or vibrate , press a Volume button, then touch  above the volume slider.
- To automatically silence your phone during a certain time (e.g. every Tuesday from 11:00 to noon), set up [Do Not Disturb](#) .

Adjust accessibility volume

When [TalkBack](#) is on, to change the volume of spoken feedback:

- Press a Volume button.

2. Move the  slider.



Fix a problem

What's wrong?

- [Phone isn't ringing](#)
- [People can't hear me on calls](#)

Turn flashlight on and off

To turn your flashlight on or off:

1. Open [quick settings](#).
2. Touch  or .

Or, make a chopping motion to turn the flashlight on or off.

If the camera opens, be sure to use a chop gesture, not a twist gesture.

To control the chop gesture:



1. [Open](#) the **Moto** app.
2. Touch  > **Moto Actions**.
3. Touch **Fast flashlight** and turn it on or off.

Use onscreen keyboard

Open and close keyboard

To open the keyboard, just touch an area where you can enter text or numbers.

To close the keyboard so you can see other parts of the screen, touch .

Tip: If you [installed](#) other keyboards, you'll see  next to the navigation buttons when you're typing. To switch to a different keyboard, touch .



Type special characters

Touch & hold a key to see related special characters. For example:



- Touch & hold **.** to see other punctuation marks.
- Touch & hold **e** to see **é** and **3**.

Tip: To insert a period followed by a space, touch the spacebar twice quickly.

Capitalize letters

To type in ALL CAPS, touch  twice, quickly, so you see . Touch it once more to turn ALL CAPS off.

To change capitalization of a word you've already typed:

- Select the word and touch  to capitalize the first letter.
- Select the word and touch  twice to make it ALL CAPS.

Use text correction

When you're typing, you'll see a list of possible words above the keys. Touch a word in the list to insert it in your text.

To turn suggestions off, turn auto-correction off, or adjust other keyboard settings:

1. Go to **Settings > System > Languages & input > Virtual keyboard**.
2. Touch **Gboard > Text correction**.
3. Turn options off or on.

Tip: For quick access to keyboard settings, touch & hold the comma key and drag it to .

Use glide typing

You have two options for entering text: type one letter at a time (multi-touch typing) or slide your finger through all the letters in a word using one continuous motion (glide typing). Both options are always available; start typing either way and switch whenever you like.

When you're using glide typing, you can:

- **Type a word.** Drag your finger over the letters in the word.
- **Delete words.** Drag left slowly from  to select a word or string of words, then lift your finger to delete.
- **Enter apostrophes in common words.** Drag through the letters and the apostrophe is automatically inserted.
- **Add a space.** There's no need to use the space bar. Just lift your finger and start the next word.



Check spelling

Spell check is always on. To spell check your text:

1. After you're done typing, review your text; misspelled words (and words not in your dictionary) are underlined in red.
2. Touch an underlined word:
 - If the word is spelled correctly, touch **Add to dictionary**.
 - If the word is misspelled, select the correct word from the list of suggestions or touch **Delete** and type the correction.

Type in multiple languages

If you have [added multiple languages](#) as a system language in your phone settings, keyboards and text suggestion are available for those languages:

- When using a keyboard language other than your primary system language, available keyboard languages are shown on the spacebar.
- To toggle between languages, touch .
- To see a list of available keyboards, touch & hold  or the spacebar.

You can [add keyboards](#) for other languages.

Adjust keyboard vibrations

The [onscreen keyboard](#) vibrates when you touch a key. Turn off vibration feedback if you prefer not to use it or want to improve battery life.



To adjust keyboard vibrations:

1. Go to **Settings** > **System** > **Languages & input**.
2. Touch **Virtual keyboard** > **Gboard** > **Preferences**.
3. Do any of the following:
 - Turn **Vibrate on keypress** off or on.
 - If on, touch **Vibration strength on keypress** and move the slider.

Tip: For quick access to keyboard settings, touch & hold the comma key and drag it to .

Cut, copy, paste text

You can select and copy text from web pages and messages.

1. To select text, touch & hold a word.
2. Touch **Copy**, **Cut**, **Share**, or:
 - Select more text. Drag the sliders .
 - Select all text in message you're composing. Touch  > **Select all**.
 - Get information about selected text. Touch **Web Search**.
 - Translate selected text. Touch  > **Translate**. (If you don't see this option, [install](#) the Google Translate app.)
3. To paste text, touch to insert at the cursor or select a block of text to replace. Then touch **Paste**.

Tips:

- In some apps, you need to double-tap a word to select it (instead of touching & holding it).
- When you use **Copy**, the text is copied to the clipboard in your phone's memory, overwriting previous text in the clipboard. If you want to save and manage everything you copy into the clipboard, search for “clipboard manager” in Play Store to select and [download](#) an app.



Use voice typing

Enable keyboard mic for dictation

If you don't see  on your keyboard:

1. Go to **Settings** > **System** > **Languages & input**.
2. Touch **Virtual keyboard** > **Gboard**.
3. Touch **Preferences** and turn **Voice input key** on .



Dictate text

1. Touch a text field to show the **onscreen keyboard**.
2. Touch  on the onscreen keyboard.
3. Speak what you want to type:
 - Speak naturally but clearly. There's no need to shout or hold the phone close to your mouth.
 - To include punctuation, say “comma,” “period,” “question mark,” or “exclamation point.”
 - To pause or restart, touch .
 - To delete a word, touch .

Fill in forms automatically

Don't retype your personal information again and again. Save it securely, then with just one touch, fill in passwords, addresses, credit cards, and other information saved to your [Google account](#).

To set it up:

1. Go to **Settings** > **System** > **Languages & input**.
2. Touch **Advanced** > **Autofill service**.
3. Select **Google**, then touch .
4. Touch  > **CONTINUE**.
5. Touch categories to review and edit personal information, addresses, credit cards, and passwords.

Get turn-by-turn directions

Navigation and battery life

Navigation is one of the most power-intensive apps, so keep your phone plugged into a high-quality car charger, especially if you're streaming music and/or using [Bluetooth](#) (also power-intensive features).

Use Directions widget

1. Before you hit the road, [add](#) a Maps Directions widget to your home screen, and you'll have directions to any destination you choose.
2. When you're ready to roll, just touch the widget, and your phone will talk you through the directions.

Tip: Combine your Directions widgets into a [folder](#) on your home screen.

Get directions to home or work

Get directions from anywhere to your home or work addresses with one touch by setting up a [task shortcut](#):

1. Touch & hold .
2. Drag **=** to a blank space on your home screen.
3. If you haven't set your home or work address yet in Maps, touch the shortcut and follow the onscreen instructions to add it.

When you're ready to roll, just touch the shortcut, and your phone will talk you through the directions.

Use voice commands to get directions

[Tell your phone](#) to provide directions to a destination:

1. Say your launch phrase.
2. Say "Navigate to [destination]."

Take screenshots

Take a screenshot

1. Do one of the following:

- Touch & hold **three fingers** on the screen.

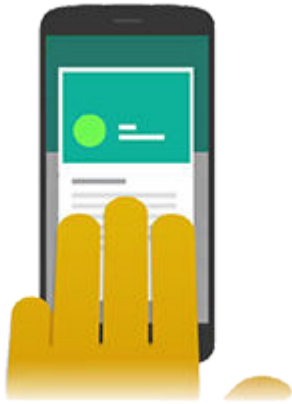

- Press & hold the Power button, then touch **Screenshot**.
 - Press & hold **Power** and **Volume Down** simultaneously until the screen is captured.
2. To scroll and capture more content, touch .
To stop scrolling before the end of the page, touch **STOP**.
 3. Do any of the following:
 - To crop the screenshot, touch .
 - To edit the screenshot, touch . Then, touch to draw on it, touch to highlight it.
 - To share it, touch .
 4. Touch **Save**.
Or, touch **Discard** to delete it.

Find screenshots later

[Open](#) the Photos app and touch > **Device folders** > **Screenshots**.

Adjust screenshot settings

Three finger screenshot and Screenshot editor make it easy to capture and enhance your screenshots. You can turn them on or off any time.

1. [Open](#) the **Moto** app.
2. Touch > **Moto Actions**.
3. Turn **Three finger screenshot** and **Screenshot editor** and on or off .

Change wallpaper

You can change the background image on your [home screen](#) or [lock screen](#). Use your own photos, images that came on your phone, or images from an online category.

Tip: If your battery is low, temporarily change animated wallpaper to a static image to save power.

1. [Open](#) the Wallpapers app.
Or, touch & hold a blank area on your home screen, then touch **WALLPAPERS**.
2. Do one of the following:
 - To set a single wallpaper, select a photo or wallpaper.
 - To see a new wallpaper each day, open a category and touch **Daily wallpaper > Continue**.
3. Touch **Set wallpaper**.
4. Select whether you want to use the wallpaper on your home screen, lock screen, or both.

Tip: To skip a daily wallpaper, [open](#) the Wallpapers app and touch  on your current daily wallpaper image.

Customize your Favorites tray

The Favorites tray at the bottom of the [home screen](#) gives you one-touch access to your most-used applications. You can customize these app shortcuts.

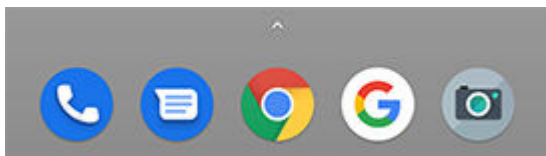

To change the app shortcuts:

1. Touch & hold one of the app shortcuts, then drag it up and drop it on **Remove**.
2. Swipe up from the bottom of the home screen to open your app list.
3. Touch & hold the app you want. When the new shortcut appears, drag it to the empty spot in your tray.

Tip: You can also use [folders](#) in your Favorites tray.

Add widgets, shortcuts, or folders

Add widgets

Widgets stream information, giving some of an app's functionality without opening the app. For example, the Calendar widget shows your daily agenda and gives you one-touch access to your full calendar.

To add a widget:

1. Touch & hold the home screen.
2. Touch **Widgets**.

Widgets are listed under their related apps.

3. Touch & hold a widget to add it.

You can make some widgets larger to view more content:

1. Touch & hold the widget until it's highlighted.
2. Release it to see an outline.
3. Drag a corner or side to resize.

Add app shortcuts

1. Swipe up from the bottom of the home screen to open your app list.
2. Touch & hold the app you want.
3. Drag the app or one of its actions to an empty spot on your home screen. Or, drag it to the edge of the screen and drop it onto a new home screen panel.

Add task shortcuts

Many apps icons include shortcuts to common tasks, so you don't have to open and navigate the app.

1. Touch & hold an app icon to see available task shortcuts.
2. Do one of the following:
 - To perform the task, touch it.
 - To create a shortcut for that task, drag **=** to an empty space on your homescreen.

Here are examples of task shortcuts for various apps. Not all apps include task shortcuts.

App	Task shortcuts
-----	----------------

-
-  Gmail
- Compose new email
 - Open to specific account
-

-  Maps
- [Navigate](#) to Work
 - Navigate to Home
-

-  YouTube
- Search
 - Subscriptions
 - Trending
-

-  Chrome
- New incognito tab
 - New tab
-

-  Calendar
- New reminder
 - New event
-

-  Messages
- Open most recent conversation
 - New conversation
-

-  Clock
- Start screen saver
 - Start stopwatch
 - Create new timer
 - Create new alarm
-

-  Settings
- Battery
 - Data usage
 - Wi-Fi
-

Add web page shortcuts

1. [Open](#) the **Chrome** app.
2. Navigate to the web page.
3. Touch  > **Add to Home screen**.
4. Edit the name if desired.
5. Touch **ADD**.
6. Do one of the following:
 - Touch & hold the icon to drag it where you want on the home screen.
 - Touch **Add automatically**.

Add folders

Folders organize your shortcuts.

1. Touch & hold an app shortcut on your home screen.
2. Drag it onto another to group them together, then release when a circle forms around them:



Then you can:

- **Add more apps.** Drag app icons onto the circle from your home screen or app tray.
- **Use an app in the folder.** Open the folder and touch the app's icon.
- **Name the folder.** Open the folder, then touch its name and type a new name.
- **Remove an app from the folder.** Open the folder and drag the app icon onto the home screen, or drag it up and drop it on **Remove**.
- **Delete the folder.** Touch & hold the folder, then drag it to **Remove**.

Fix a problem

If you're having problems, try these [troubleshooting steps](#).

Remove widgets, shortcuts, or folders

Easy come, easy go. To remove items that you [added](#) to your [home screen](#):

1. Touch & hold it until it vibrates.

2. Drag it up and drop it on **Remove**.

To select a totally new user interface for your home screen, download a [different launcher](#).

Use Time and Weather widget

Add widget to home screen

Put a clock on your home screen and get quick access to alarms, your calendar, and the weather.



1. Touch & hold the home screen.
2. Touch **Widgets**.
3. Touch & hold the **Time and Weather** widget, then drag it to a home screen page.

Set or delete alarms



1. Touch the time.
2. Do one of the following:
 - To use an existing alarm, switch it on . Touch to view or edit its ringtone.
 - To add a new alarm, touch and set the time and ringtone.
 - To delete an alarm, touch next to it, then touch .
3. To control general alarm settings, like alarm volume and snooze duration, touch **Settings**.

When an alarm is set, shows in the [status bar](#).

Manage cities for weather forecasts

The Time and Weather widget displays current temperature for your location or for a city you specify.



To display the temperature for your current location:

1. Do one of the following:
 - Touch **Add cities**.
 - Or, touch the current temperature, then touch  > .
2. Turn **Current location** on.

Tip: To switch between Fahrenheit and Celsius, touch **Temperature units**.



To see a forecast, touch the current temperature on the widget.

To add a city:

1. Do one of the following:
 - If you haven't added locations yet, touch **Add cities**.
 - Or, touch the current temperature, then touch .
2. Touch **Add new location**.
3. Enter a city name or ZIP code, then touch .
4. Touch the city to add.

Tip: To switch between forecasts for multiple cities, touch the temperature, then swipe left or right.

To remove a city:

1. Touch the temperature.
2. Touch  > **Settings**.
3. Touch  next to the city's name.

View your calendar

Touch the current date to open your calendar, where you can view or add upcoming [events](#).

Remake your home screen with launchers

Get different launcher

Totally changing the look and feel of your [home screen](#) is easy to do. Just select and download a new launcher app. Switch back to the standard look and feel at any time. Launchers

frequently include new sets of wallpapers, new gestures for interacting with your phone, and customizable elements for your home screen.

1. Search for “launcher” in [Play Store](#) .
2. Read through the choices and download the one (or more) that you want.
3. To start using it, open the app or follow the onscreen instructions after downloading it.

Switch between launchers

1. Go to [Settings](#) > **Apps & notifications** > **Advanced**.
2. Touch **Default apps** > **Home app**.
3. Select the launcher you want to use.

Delete launchers

You can only delete launchers that you installed.

Touch & hold the launcher's app icon, then touch  > **Uninstall**.

Use a screen saver

Set up screen saver



While your phone is idle on a dock or charger, turn it into a desk clock, a photo frame to show off your pics, or more.

1. Go to **Settings** > **Display** > **Advanced**.
2. Touch **Screen saver**.
3. Do any of the following:
 - To change screen savers, touch **Current screen saver**, then select one. To set options for that screen saver, touch .
 - To preview your selection, touch **Start now**. Touch the screen anywhere (unlock if necessary) to return to settings.
 - To adjust when the screen saver starts (while docked, charging, or either), touch **When to start**.

Start screen saver

The screen saver automatically starts when you connect your phone to a dock or charger and the screen goes to sleep.

To exit the screen saver and return to your home or lock screen:

- Press the Power button.
- Or, touch , , or .

To manually start your screen saver any time, go to **Settings** > **Display** > **Advanced** > **Screen saver** and touch  > **Start now**.

Turn off screen saver

To prevent the screen saver from starting automatically:

1. Go to **Settings** > **Display** > **Advanced**.
2. Touch **Screen saver** > **When to start** > **Never**.

Add screen savers

Search for “Screen saver” in Play Store for apps that give you more.

After you **install** an app, you can select the new ones in **Settings** > **Display** > **Advanced** > **Screen saver**.

Set screen lock

Screen lock options

When you set a screen lock, each time you turn on your phone or [wake the screen](#), you'll be asked to unlock your phone.

No lock:

- **None:** This gives no protection, but you can quickly access your home screen.
- **Swipe:** Swipe  up. This prevents accidental dialing but doesn't secure the phone.

Lock:

- **Pattern:** Draw a pattern on a grid.
- **PIN:** Enter a four to sixteen digit numeric code. Longer PINs are more secure.
- **Password:** Enter four to sixteen letters, digits, or symbols for the password. A long, strong password is the most secure option.

When you're using any of the 3 locks, you can also unlock with your [fingerprint sensor](#) and set your phone to [automatically unlock](#) in certain conditions.

Set or change screen lock

1. Go to [Settings](#) > **Security & location**.
2. Touch **Screen lock** and select the type of lock you want.

Some options aren't available if you added a [VPN](#) or a work (corporate) email account to your phone.



Hide your password or pattern

You can hide your password or pattern to prevent others from viewing it when you unlock your screen.

For passwords:

1. Go to [Settings](#) > **Security & location** > **Advanced**.
2. Turn **Show passwords** off .

For patterns:

1. Go to [Settings](#) > **Security & location**.
2. Touch .
3. Turn **Make pattern visible** off .

Quickly tighten lock screen security

Unlocking with the [fingerprint sensor](#) and setting up [automatic unlocking](#) make it easier to keep your phone secure and minimize when you need to enter your PIN, pattern, or password. But sometimes you need to trade convenience for more security. You can temporarily tighten locks and prevent lock screen notifications.

To set it up:

1. Go to [Settings](#) > [Security & location](#) > [Lock screen preferences](#).
2. Turn **Show lockdown option** on .

To use it:

1. Touch & hold the Power button.
2. Touch **Lockdown**.

Your fingerprint sensor and automatic unlock settings are disabled and notifications won't be displayed on your lock screen.

3. To exit Lockdown, unlock your phone with your PIN, pattern, or password.

Unlock your screen automatically

If you're using a PIN, password, or pattern, you can:

- Stay unlocked when [connected to a device](#), like your car audio system.
- Stay unlocked at a [specific location](#).
- Stay unlocked when [holding or carrying](#) your phone.
- Unlock with [your face](#).
- Unlock with [your voice](#).

Tips:

- You can swipe up from anywhere on the screen when unlocking. You don't need to touch the  icon.
- Some of these options aren't available if you added a [VPN](#) or a work (corporate) email account to your phone.

Fix a problem

If you forgot your PIN, pattern, or password, try these [troubleshooting steps](#).

Add message to lock screen

To add your name or a short message to your [lock screen](#) for anyone who finds your phone:

1. Go to **Settings** > **Security & Location**.
2. Touch **Lock screen preferences** > **Lock screen message**.
3. Type the text to display and touch **Save**.

Tip: Don't put your mobile number as your contact info unless you can access your voicemail from another device.

Set ringtones



Change default call ringtone

1. Go to [Settings](#) > **Sound**.
2. Touch **Phone ringtone**.
3. Do one of the following:
 - Select a ringtone from the list.
 - To use a song as the ringtone, touch **Add ringtone** at the bottom of the list. Then touch  > **Audio** and select the song [stored on your phone](#).
 - For silence, touch **None** at the top of the list.

Vibrate phone for calls



You can set the phone to vibrate when it rings for calls.

To extend battery life, turn vibrate off.

1. Go to [Settings](#) > **Sound**.
2. Turn **Also vibrate for calls** on  or off .

Set call ringtone for a contact

You can choose a unique ringtone for calls from specific people so you'll know instantly who's calling.

1. [Open](#) the  **Contacts** app.
2. Touch the contact's name.
3. Touch  > **Set ringtone**.
4. Do one of the following:
 - Select a ringtone from the list.
 - To use a song as the ringtone, touch **Add ringtone** at the bottom of the list. Then touch  > **Audio** and select the song [stored on your phone](#).
 - For silence, touch **None** at the top of the list.

Set ringtone for app notifications

You can set a default sound for notifications from apps including messaging and email. You can also set a unique ringtone for notifications from specific apps. [Learn how](#).



Tip: To change your [alarm sound](#), open the Clock app and touch . Then touch .

Get more ringtones

Although your phone comes with lots of ringtones, you can get more:

- Search for “ringtones” in [Play Store](#) and install an app that provide ringtones.
- Search for “ringtone maker” in [Play Store](#) and install an app that lets you create custom ringtones. Open the app and use it to select entire songs or portions of songs.
- If you have songs that are .mp3 files stored on your computer, [connect](#) your phone and computer with a USB cable, then copy the song to your phone.

Fix a problem



If you're not hearing your ringtones, look for  in your [status bar](#), which means you're in [Do Not Disturb](#) mode. Open [quick settings](#) and touch  to turn Do Not Disturb off.

Avoid interruptions with Do Not Disturb

Turn Do Not Disturb mode on or off

When you're busy, use Do Not Disturb to silence your phone. You can mute sounds, stop vibration, and block visual disturbances.

To turn it on or off:

- To block interruptions, open [quick settings](#) and touch . You'll see  in the status bar when Do Not Disturb is on.
- To turn Do Not Disturb off, open [quick settings](#) and touch .

Tip: Put your phone face down on a surface to start Do Not Disturb. (To enable this gesture, open the **Moto** app and touch **Moto Actions** > **Flip for DND** and turn it on .)

Change Do Not Disturb duration



Pick how long Do Not Disturb should stay on, when you turn it on in quick settings.

1. Open [quick settings](#), then touch & hold .
2. Touch **Duration**.
3. Choose one:

- To keep it on indefinitely, touch **Until you turn off**.
- To select a duration, touch **For 1 hour**, then touch + or - to adjust the time.
- To choose each time, touch **Ask every time**.

Allow exceptions in Do Not Disturb mode

When Do Not Disturb is on, incoming calls, messages, and calendar events or reminders are muted. You can allow exceptions:

1. Open [quick settings](#), then touch & hold .
2. To pick whose calls get through, touch **Calls** and then:
 - Touch **Allow calls** and choose whether to allow calls from anyone, from contacts only, from [starred](#) contacts only, or none.
 - To let calls through from repeat callers (the same person calling a second time within 15 minutes), turn **Allow repeat callers** on .
3. To pick whose text messages get through, touch **Messages, events & reminders > Allow messages** and then choose all, contacts only, [starred](#) contacts only, or none.
4. To allow notifications for calendar events and reminders to get through, touch **Messages, events & reminders** and turn them on .

You can also control whether alarms and media can sound:

1. Open [quick settings](#), then touch & hold .
2. Touch **Sound & vibration**.
3. Choose which sounds to allow when Do Not Disturb is on.

Stop visual disturbances in Do Not Disturb mode

When your phone is in Do Not Disturb mode, you can prevent silenced notifications from:

- Turning the screen on when it's off
- Peeking or popping up when your screen is on
- Showing notification dots, status bar icons, or updating the notification list

To block these disturbances:

1. Open [quick settings](#), then touch & hold .
2. Touch **Notifications**.
3. Do one of the following:
 - To block all visual notifications, touch **No visuals or sound from notifications**.

- To block selected visual notifications, touch **Custom** and turn features on or off.

Automatically silence phone during set days and times

You can create a schedule for when your phone should automatically switch into and out of Do Not Disturb mode.

1. Open [quick settings](#), then touch & hold .
2. Touch **Turn on automatically**.
3. Use rules to set the schedule:
 - To use an existing rule, touch its name, like **Sleeping**. Turn **Use rule** on and adjust times or settings as needed.
 - To create a new rule, touch **Add rule**. Touch **Time**, then enter a name and touch **OK**. Specify its days, start and end times, and level of silence.

To stop your phone from automatically silencing, go to [Settings](#) > **Sound** > **Do Not Disturb**. Select the rule and turn it off or touch  to delete it.

Automatically silence phone during calendar events

Your phone can automatically switch into and out of Do Not Disturb mode for all scheduled events in calendars that you specify.

1. Open [quick settings](#), then touch & hold .
2. Touch **Turn on automatically**.
3. Do one of the following:
 - To use an existing rule, turn it on.
 - To create a new rule, touch **Add rule**. Touch **Event rule**, then enter a rule name and touch **OK**.
4. Adjust options to select the calendar to use and your reply status.

To stop your phone from automatically silencing, go to [Settings](#) > **Sound** > **Do Not Disturb**, then select the rule and turn it off or touch  to delete it.

Silence power on sound

If you don't want your phone to make a sound when it powers up:

1. Go to [Settings](#) > **Sound** > **Advanced**.
2. Turn **Power on sounds** off .

You can't adjust the volume level for this sound.

Stop phone from speaking

Some [voice commands](#) (like “What's up?” and “What is the current weather?”) cause your phone to speak in response.

To stop the phone from speaking temporarily, touch .

To prevent your phone from speaking:

1. [Open](#) the **Google** app.
2. Touch  > **Settings**.
3. Touch **Voice**.
4. Turn off **Speech output**.

Turn off charging sounds

If you don't want your phone to make a sound when it comes in contact with a charger:

1. Go to [Settings](#) > **Sound** > **Advanced**.
2. Turn off **Charging sounds**.







About your apps

Open an app

Swipe up from the bottom of your home screen, then touch the app to open.

Pre-loaded apps

The following apps are pre-loaded on your phone. Don't want some? [Delete or disable them.](#)

Icon	App	Description
	Calculator	Make some quick calculations.
	Calendar	Keep track of your upcoming events, get automatic reminders on your phone, and coordinate with others by sharing calendars.
	Camera	Capture photos or videos. Learn more.
	Chrome	Browse the web. Access your browser bookmarks from any device, and sync tabs with your computer or Android devices.
	Clock	Set alarms . Use a timer or stopwatch.
	Contacts	Organize and connect with your contacts. Assign ringtones to people.
	Docs	Create, edit, and collaborate with others on documents.



Drive

Store and synchronize your files on Google's cloud, then access them anywhere you have an internet connection. Create and share spreadsheets, documents, and presentations. [Scan](#) documents and share or print them.



Duo

Make video call with your friends across Android and iOS.



Facebook

Connect with friends, family, and communities. Share updates and media. Find information on events, entertainment, and businesses.



Files

Browse and manage files and folders stored on your device or [SD card](#).



FM Radio

Listen to FM radio stations.



Gmail

Compose, send, view, or search your email from your phone or computer.



Google

[Search](#) the web, see your information cards, and adjust Google settings, including [privacy](#).



Maps

[Find your destination](#), explore locations.



Messages

Send and receive text messages.



Moto

Select available gestures for phone shortcuts and control notifications.



News and
Weather

See headlines, weather, and information on your favorite topics and locations.



Phone

[Make calls.](#)



Photos

Manage photos and [upload](#) them automatically to your private album.



Play Movies & TV

Get movies and TV shows for instant viewing from Play Store.



Play Music

[Listen](#) to your music collection (stored on your phone or streamed). Shop for new music. Create playlists, listen anywhere.



Play Store

[Get apps](#) for your phone, as well as books, magazines, music, and movies and access them from your computer or any Android device.



[Settings](#)

Customize your phone settings.



Sheets

Create, edit, and collaborate with others on spreadsheets.



Slides

Create, edit, collaborate with others, and play presentations.



Wallpapers

[Change](#) your wallpaper, get new ones, or automatically show a new one every day.





YouTube



Find, view, and upload videos to the web.

Get more apps



Don't see what you need? [Download more apps](#).

Tip: Swipe up  and touch  **Search apps**. Type the missing app's name to go to Play Store where you can install with one touch.



Get help for an app

1. Open the app.
2. Touch  or .
3. Look for **Help** or **Settings > Help**.



Switch between recent apps

1. Touch  to see your recently used apps.
Or, if you're using the [navigation bar](#), swipe up on .
2. Do any of the following:
 - Touch any app screen to return to it.
 - Swipe left or right to see more apps.
 - Swipe an app up to remove it from the list.
 - To clear the list, swipe all the way right and touch **CLEAR ALL**.

Tips:

- Touch  twice to switch between your two most recently used apps. (If you're using the [navigation bar](#), swipe right on .)
- Use two apps at once with [split screen](#).

Close apps



To get out of an app, touch  to return to your home screen. Or, touch  if you're using the [navigation bar](#).

You don't need to close apps. Android manages the memory and battery that apps use, so you don't need to worry about leaving apps open.

To remove apps from your recently used list:





1. Touch .
2. Do one of the following:
 - To remove one app, swipe up to remove it from the list.
 - To remove all apps, swipe right to the end of the list and touch **CLEAR ALL**.

Tips for using apps

- You can [change the background color](#) of your app list to be light or dark.
- You can [print](#) from many apps.
- [Copy and paste](#) text between apps with the clipboard.
- [Tap & pay with your phone](#), using a payment app and NFC.
- To organize apps into groups on your home screen, use [folders](#).
- Touch & hold an app's icon to see [task shortcuts](#), if any. Touch a task to perform it. Or, drag  to your home screen to create a shortcut for that task.
- Want to turn the flashlight on or off? Use [quick settings](#) ( or ). No app required.
- If you're having problems with an app, try these [troubleshooting steps](#).

Use two apps at once

Use split screen view





1. Open the first app.
2. Touch .
3. In the recent list, touch the app's icon, at the top of the app's preview, to see  and .
Be sure to touch the app's icon instead of the preview, which opens the app.
4. Touch  **Split screen**.
5. Select the second app to use.

Exit split screen view

Drag the black divider all the way up or down.

Use Picture-in-picture

With some apps, you can watch video in a small, movable frame while you do other things. Use it when [navigating](#) with Google Maps, too.

1. When you're playing a video or navigating with Maps, touch .
The video (or navigation) shrinks.
2. You can drag the video (or navigation) anywhere on the screen.
 - To return it to full size, touch it twice.
 - To close it, drag it to the bottom of the screen. Or, touch it, then touch .
 - To turn off Picture-in-picture for the app in use, touch it, then touch  and turn **Allow picture-in-picture** off .

To see all apps that support Picture-in-picture:

1. Go to [Settings](#) > **Apps & notifications** > **Advanced**.
2. Touch **Special app access** > **Picture-in-picture**.
3. To turn off Picture-in-picture for an app, touch it and turn **Allow picture-in-picture** off .

Install or update apps

Get apps from Google Play Store



Need a voice recorder, notepad, or compass? You can download more apps, in addition to [pre-loaded apps](#) on your phone.

To download apps:

1. [Open](#) the **Play Store** app.
2. Browse by category or search.
3. Touch an item to see a description, read reviews, and download it.

You'll see  in the [status bar](#) when the app has downloaded and installed successfully.

Tips:

- To view Play Store apps you've installed on this phone, touch  > **My apps & games**. Touch **LIBRARY** to see apps you've installed on other devices using the same Google account.
- To prevent accidental or unwanted purchases, touch  > **Settings** > **Require authentication for purchases**.

Get apps from other sources

Before downloading, do some research: check the app's rating and read lots of comments.

To download apps:

1. [Open](#) the **Chrome** app and go to the appropriate site to download the app.

If you see a warning, touch **OK** to continue.

You'll see  in the [status bar](#) when the download completes.

2. Touch the download notification to install the app. Or, open the **Files** app to install it later.
3. When installing the app, be sure to review what information the app will access. If you don't want the app to access this information, cancel the installation. For example, if you're installing an app that makes a shopping list, the app should not require access to your contacts.

Update Play Store apps automatically

Updating your apps gives you the latest features and improves security and stability. For best performance, apps are set to update automatically.

If an app changes the information it wants to access on your phone, you will receive a notification to update the app manually and will be required to review and accept the new permissions.

To control when your apps are automatically updated:



1. [Open](#) the **Play Store** app.
2. Touch  > **Settings**.
3. Touch **Enable auto update**.
4. Do one of the following:
 - To save data charges on your cellular plan and update only when connected to Wi-Fi, touch **Auto-update apps over Wi-Fi only**.
 - To update using either Wi-Fi or cellular data, touch **Auto-update apps at any time**. **Data charges may apply**.

Update Play Store apps manually

1. [Open](#) the **Play Store** app.
2. Touch  > **My apps & games**.
3. On the UPDATES tab, touch **Update all**, or to update a specific app, touch **Update** next to its name.
4. Read the summary of what changed, then swipe down to review any changes to permission details, what information on your phone the app can access. If you agree, touch **Update**.

Turn off Play Store auto-updates

To stop a specific app from updating automatically:



1. [Open](#) the **Play Store** app.
2. Touch  > **My apps & games**.
3. Touch the **INSTALLED** tab, then touch the app's name.
4. Touch  and turn off **Enable auto update**.

To stop all apps from updating automatically:

1. [Open](#) the **Play Store** app.
2. Touch  > **Settings**.
3. Touch **Enable auto update** > **Do not auto-update apps**.

Restore Play Store apps

If you [uninstall](#) an app you got from Play Store, you can reinstall it anytime. Have apps you use infrequently, such as a flight tracker? Delete them and easily reinstall when needed.

1. [Open](#) the **Play Store** app.
2. Touch  > **My apps & games**.
3. Touch the **LIBRARY** tab for a list of every app you've downloaded.
4. Next to the app name, touch **INSTALL**.
5. If you have multiple Google accounts, touch  and next to your account touch . Select the other account and repeat the process to restore apps downloaded in that account.

Manage or delete apps

Organize apps

To organize apps into groups on your home screen, use [folders](#).

Control app permissions

The first time you use an [app](#), and sometimes when you [install or update it](#), you are asked to grant the app permission to access certain data and phone features. You can adjust these permissions any time.

To adjust permissions by app:

1. Touch & hold the app icon, then touch .
2. Touch **Permissions**.
3. Turn each permission on or off as needed.

Tip: To see how the app uses each permission, touch  > **All permissions**.

You can also review each feature and [adjust which apps have permission](#).

Use safe mode

Issues such as apps crashing, unexpected reboots, or fast battery drain could be caused by a third-party app. Use safe mode to start your phone with only the original software and apps. If the issues go away in safe mode, the problem is probably from a third-party app you downloaded.

To reboot in safe mode:

1. Press & hold the Power button.
2. Touch & hold **Power off**. Then touch **OK** to restart in safe mode.

When it restarts, you'll see **Safe mode** across the bottom of the home screen and widgets will be disabled.

3. Use your phone and see if the problem has gone away. Remember, you won't be able to use any downloaded apps.

If the problem goes away:

1. To exit safe mode, restart your phone.
2. One by one, uninstall recently downloaded apps. After each removal, restart your phone. See whether removing that app solved the problem.
3. Once you delete the problematic app, you can [restore](#) the other apps you removed during testing.

If the problem doesn't go away: Try these [troubleshooting steps](#) for phone performance issues.

Clear app's cache or data

Clearing the cache can free up phone memory, improve performance, and fix some problems with apps and web pages.

1. Touch & hold the app icon, then touch .
2. Do one of the following:
 - To free up space by removing temporary files, touch **Storage** > **Clear cache**. Over time, the cache builds up again, so repeat if a problem occurs.
 - If problems still occur, then delete all data saved in the app by touching **Storage** > **Clear storage**. Be careful - there's no way to undo this.

Force stop apps

Force stop an app only if it seems to be causing a problem. To completely shut down an app, including any background services:



1. Touch & hold the app icon, then touch .
2. Touch **Force stop**.

Delete apps you installed

You can delete (uninstall) apps that you downloaded. For many [pre-loaded apps](#), you can disable but not delete them.

1. Touch & hold the app's icon.

2. Do one of the following:

- Drag the icon up and drop it on . This removes the app and frees storage space.
- If you don't see a delete option, touch & hold the app icon, then touch  > **Disable**.

Delete apps installed by others

If you are the [owner](#) of the phone and share it with [users](#) or [guests](#), you can uninstall apps they installed. Although their apps don't appear in your app tray or on your home screen, they do reduce available storage space.

1. Go to [Settings](#) > [Apps & notifications](#) > [App info](#).

Apps installed by others show the message **Not installed for this user**.

2. Touch the app name.

3. Touch  > **Uninstall for all users**.

Back up apps and settings

You can use your [Google account](#) to back up:

- App data
- Call history
- Phone settings (wallpaper, Wi-Fi passwords, default apps)
- SMS text messages

To back up apps and settings:

1. Go to [Settings](#) > [System](#).

2. Touch **Backup**.

3. Turn on **Back up to Google Drive**.

4. If you have multiple Google accounts, touch **Account** to select an account.



Protect against harmful apps

Scan phone for harmful apps

Play Protect helps keep your phone secure by automatically scanning your phone to check for potentially harmful apps.

If Play Protect finds a potentially harmful app, it stops the app from running and warns you so you can uninstall it.

To see the results or to rescan:

1. [Open](#) the **Play Store** app.
2. Touch  > **My apps & games**.
3. Do any of the following:
 - To see the results of latest scan, on the UPDATES, look at the message next to .
 - To rescan your phone, touch .

If your phone seems slow

If you've scanned your phone to confirm there aren't any potentially harmful apps but your phone seems slow, try these [troubleshooting steps](#).

Pin your screen



Turn on screen pinning

Use screen pinning to keep the current screen or app in view until you unpin it. For example, you can pin a game and your child cannot navigate anywhere else on your phone.

You can set up a pattern, PIN, or password required to unpin the screen.

1. Go to [Settings](#) > **Security & location** > **Advanced** > **Screen pinning**.
2. Turn screen pinning on.
3. By default, you must always enter your pattern, PIN, or password when unpinning a screen. If you don't want this security before accessing your other phone screens, turn this option off.

Pin a screen

1. Make sure you've turned on screen pinning in [Settings](#) .
2. Open an app and go to the screen you want to pin.
3. Touch .
4. Touch the icon of what you want to pin.
5. Touch .

Unpin a screen

1. Touch & hold  and  at the same time.

2. If you required a pattern, PIN, or password when you [turned on pinning](#), enter it to unlock the phone.

Search the web

Search with the widget

To type your search term:

1. Touch the Search widget.

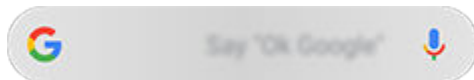

2. Start typing a search term.
As you type, suggested terms appear.
3. Touch a suggestion to search for it.

Search from anywhere

You don't have to leave your current app to search for the info you need. Use Google Assistant from any screen to get search results and options for your next action.

To search:

1. Say "OK, Google" or "Hey, Google". (Be sure you've [set up the launch phrase.](#))
Or touch & hold .
2. Tell the assistant what you're looking for. For example, search for a local restaurant by saying "Find [restaurant name]."
3. Below the search result, touch options for related actions: make a call, get directions, read reviews, and more.

Search history must be [turned on](#) to use Google Assistant.

For more help with Google Assistant, read [Google's support information](#).

Search from Gboard

When you're typing with the [onscreen keyboard](#):

1. Touch  above the keys.
2. Start typing a term in the search bar.
3. Touch a result to share its link, or touch one of the additional suggested searches for more information.



If you don't see  on your keyboard:

1. Go to [Settings](#) > [System](#) > [Languages & input](#) > [Virtual keyboard](#).

2. Touch **Gboard** > **Search**.
3. Turn **Show "Search and more" button** on .

Search for nearby phone numbers



To find and call a nearby business:

1. [Open](#) the  **Phone** app.
2. Touch .
3. Say or type the name of place to call, or a search term about the place (for example, "restaurant").

You'll see a list of nearby search results.

4. Touch the place to dial its number.

If it doesn't work:



- Make sure [Location](#) is enabled.
- Touch  >  > **Settings** and turn **Nearby places** on.

Use SafeSearch

To help prevent adult content from appearing in your search results:

1. [Open](#) the **Google** app.
2. Touch  > **Settings**.
3. Touch **Accounts & privacy**.
4. Turn on **SafeSearch filter**.

Delete Google search history

1. [Open](#) the **Google** app.
2. Touch  > **Settings**.
3. Touch **Accounts & privacy**.
4. Touch **My Activity**.
5. Touch  > **Delete activity by**.
6. Select the timeframe and choose **Search** as the product.
7. Touch **Delete**.

You can also [review, delete, and control](#) other information Google collects about you.

Use search engine other than Google

To use a search engine other than Google:

1. Search for “search engine” in Play Store and [install](#) one of the apps.
2. Open that app to search.
3. Optionally:
 - [Delete](#) the Google search widget from your home screen. If you can't delete it, use a [different launcher](#) for your home screen that doesn't include the widget.
 - Install a browser to replace Chrome and make it [your default browser](#).
 - [Turn off](#) Google's collection of your information.

Search your phone

Search contents of your phone

1. Touch the Search widget.

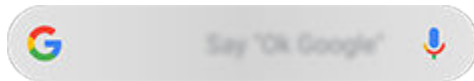

2. Enter a search term.
3. On the search results page, under , swipe left and change **ALL** to **PERSONAL**.

If you're not seeing results:

1. [Open](#) the **Google** app.
2. Touch  > **Settings**.
3. Touch **Personal**.
4. Make sure that everything you want to include in your searches is checked.

Find an app

1. Swipe up from the bottom of the [home screen](#) to open your app list.
2. Touch  **Search apps**.
3. Type the app's name.
4. If the app is on your phone, touch its icon to open it.

If the app isn't on your phone, touch **SEARCH FOR MORE APPS** to go to Play Store and install with one touch.

Find your phone number

1. Go to [Settings](#) > **System**.
2. Touch **About phone** > **Phone number**.

Find photos, videos, files

To find photos or videos on your phone, use the Photos app.



To find downloaded files, use the [Files app](#).

Use camera to scan and search

Scan QR codes and barcodes

Scan QR codes or barcodes with your camera. Then use the scanned information.

1. Open the  Camera app.
2. Place the viewfinder over the item to automatically begin the scan.
3. Touch an icon:

To do this	Touch
View website.	
Start web search .	
Copy information to clipboard to be pasted into an email, text, or elsewhere.	

You can also scan documents and save them as PDFs to print or share using [Drive](#) .

Translate text with camera

Use the Translate app to translate signs and text as you view them with the camera.







1. Open the **Translate** app.
If you don't have this app, you can [install it](#) from Play Store.
2. Use  to select the languages (to/from) for translation.

3. Touch .
4. Frame the text, holding the phone steady.
The camera scans and translates in the viewfinder.

Browse websites

Visit and bookmark websites



Your phone connects to your carrier's cellular network or to a Wi-Fi network to access the internet. To save data charges on your cellular plan, use a [Wi-Fi connection](#).

1. Open the  **Chrome** app.
2. Go to a site by touching the bar at the top and typing the address.
3. On a web page:
 - To bookmark it, touch  > .
 - Or, touch  > **Add to Home screen** to put a [shortcut](#) on your home screen.
 - To search for text on that page, touch  > **Find in page**.
 - To open a link, touch it.
 - To see options for opening a link in a new tab and copying or sharing a link, touch & hold the link.
 - To print the page, touch  > **Share** > **Print**. Be sure you set up your [print service](#).
4. To return to the previous page touch .

To learn more about browsing or managing bookmarks, open Chrome and touch  > **Help & Feedback**.

Open and switch browser tabs



In the  **Chrome** app:

- To switch tabs, touch the switcher icon .
- To open a new tab, touch touch the switcher icon , then touch .

Browse privately with incognito tabs

If you don't want Chrome to remember your activity, use incognito tabs.



To open a new incognito tab with one touch from your home screen, add a [task shortcut](#):

1. Touch & hold .
2. Drag  to a blank space on your home screen.

To close all incognito tabs:

1. Swipe the [status bar](#) down.
2. Touch .

Clear browsing history

1. [Open](#) the  **Chrome** app.
2. Touch  > **History**.
3. Touch **CLEAR BROWSING DATA**.

You can also review and delete your [search history](#).

Change default browser

You can [download](#) other browsers from Play Store. After you've installed one, you can make it your [default](#) browser.

1. Go to [Settings](#) > **Apps & notifications**.
2. Touch **Default apps** > **Browser app**.
3. Touch the app to use.

Fix a problem

For problems with  Chrome, read [Google's troubleshooting information](#).

About text and multimedia messages

Text messages - SMS

SMS (Short Message Service) messages contain text only. One text message can contain 160 characters; when you near the limit, a counter appears. If you type more, your message is sent in a series of SMS messages.

You can send one SMS message to multiple people, and replies are delivered in separate, not group, conversation threads (unless you and your recipients have group messaging enabled).

SMS messages are included in most carriers' text messaging plans and do not use cellular data.

Multimedia messages - MMS

MMS (Multimedia Messaging Service) messages can include unlimited text plus a photo, picture slideshow, video, or sound file.

You can send one MMS message to multiple people using group messaging, containing text only or text and media, and replies are delivered in group conversation threads to each person in the group.

MMS messages use cellular data and require a cellular data plan or pay-per-use payment.

Group messaging

Group messaging lets multiple people carry on a group conversation. All replies from recipients are delivered to all recipients, in a group conversation thread.

Though you send one message to multiple recipients, you are charged for each message received. Group messaging:

- Converts multiple-recipient SMS messages to MMS for all who can receive them
- Is available for MMS messages only





Note: Recipients who cannot receive MMS messages receive SMS instead and, if media is attached, a link to download it over Wi-Fi (when offered by carrier). Replies are to the sender only, in an individual conversation.

If you don't want to receive replies in group conversations, you can [turn off group messaging](#) in the Messages app.

Read, send, manage text messages

Read and reply to a text message





When you receive a [text message](#) with the  Messages app, you'll see  in the [status bar](#).

1. Swipe the status bar down and touch .
2. Do any of the following:
 - To respond to the message, enter your response in the text box and touch .
 - If the message is from an unassigned number, [create a contact](#) to associate a name with that number.
 - To open an attached photo, slideshow, or any type of attachment, touch it.
 - To [save an attachment](#), touch & hold it, then touch .
 - To find a message, touch  at the top of your message list and enter search terms.
 - To learn about something mentioned in the message, touch & hold . [Google Assistant](#) shows details, apps, and actions related to the message's contents.



Tips:



- If you don't want multi-recipient SMS messages converted to MMS and want replies sent in separate conversations (threads) to you only, [turn off](#) group messaging.
- To protect your privacy, you can [hide sensitive content for lock screen notifications](#).

Send text message

1. [Open](#) the  **Messages** app.
2. Touch .
3. Enter recipients, then type the message.
4. Optionally:
 - [To add an attachment](#), touch .
 - To add a smiley or other icons, touch  on the [onscreen keyboard](#).
5. Touch .



Tips for sending messages:

- To text your best friend with one touch from your home screen, add a [task shortcut](#). Touch & hold  and drag  to your home screen.

- To **change** the text message reply to incoming calls, open the  Phone app and touch  > **Settings** > **Quick responses**.

Request text delivery reports

See whether recipients receive your messages by requesting delivery reports.



1. **Open** the  **Messages** app.
2. Touch  > **Settings**.
3. Do one of the following:
 - If you have a single SIM, touch **Advanced**.
 - If you have dual SIMs, touch the SIM.

Manage draft texts



When you begin composing a text message reply or a new message with recipients, it is saved in your message list as a draft until you send or delete it.

1. Open the message list and touch the conversation marked **Draft**.
2. Do one:
 - Finish composing the message and touch .
 - Delete the characters in the text field to delete the draft.

Forward a text message

1. **Open** the  **Messages** app.
2. Open the conversation.
3. Touch & hold the message.
4. Touch .

Copy text from a message

1. **Open** the  **Messages** app.
2. Open the conversation.
3. Touch & hold the message.
4. Touch .

You can now **paste** it elsewhere, like in an email you're **composing**.

Delete or archive texts

When you delete a message, you also delete any attached photos or videos. If you want the attachments, be sure to [save them](#) before deleting the message.

- To delete a single message, open the conversation (thread) and touch & hold the message, then touch .
- To delete or archive all messages in a conversation, touch & hold the conversation, then touch  to delete or  to archive.
- To delete or archive multiple conversations, touch & hold each conversation, then touch  or .
- To see archived messages, touch  > **Archived**.





Fix a problem

If you're having problems, try these [troubleshooting steps](#).



Add attachments

Attach files to text message

You can attach saved pictures and videos, or take one right from your message that has an optimized, reduced file size.

1. [Open](#) the  **Messages** app.
2. Compose a [reply](#) or a [new message](#).
3. Touch .
4. Choose the type of attachment (such as photo, emoji or GIF, your location, a recording).
To learn more, touch  > **Help & Feedback** in the  Messages app.
5. Touch .

Send contact as text message

1. [Open](#) the  **Messages** app.
2. In the message list, touch the contact's icon  to open the contact's information. (Touch the icon, not the name. Touching the name opens the conversation instead of contact information.)
3. Touch  > **Share**.

4. Touch the recipient's name, or touch **Messages** to start a new message.
5. Touch .

Fix a problem

If you're having trouble attaching files, check that:

- Cellular data is [turned on](#).
- Your data plan supports MMS (multimedia messages).

Save attachments from text message

If you received an attachment to a [text message](#), you can save it on your phone. In the message, just touch & hold the attachment, then touch  to save it.

To view the saved attachment:

- For photos or videos, [open](#) the Photos app and touch  > **Device folders** > **Download**.
- For other attachments, [open](#) the Files app.



If you do not save a photo or video from a message, it is kept within the message only. So, if you delete the message, you also delete the attachment. (You can try to [recover](#) recently deleted messages.)

Turn group messaging on or off

Group messaging allows conversation participants to reply to all recipients in a single thread. If you do not want multi-recipient SMS messages converted to MMS and want replies sent in separate threads only to you, turn off group messaging.

This feature is not available in all countries.

To adjust the group messaging setting:

1. In the  Messages app, touch  > **Settings** > **Advanced**.
2. Do one of the following:
 - If you have a single SIM, touch **Advanced**.
 - If your phone allows dual SIMs, touch the SIM you use for text messaging.
3. Check or uncheck **Group messaging**.

Change default messaging app



You can [download](#) additional messaging apps from Play Store. After you've installed one, you can make it your [default](#) messaging app.

To select a different app to send and receive text (SMS) and multimedia (MMS) messages:

1. Go to **Settings** > **Apps & notifications**.
2. Touch **Default apps** > **SMS app**.
3. Touch the app to use.

Control notifications for text messages

If you use the Messages app:



1. [Open](#) the  **Messages** app.
2. Touch  > **Settings**.
3. If you have dual SIMs, touch **General**.
4. Touch **Notifications** and turn notifications on or off, change the sound, and add or remove vibration.

If you use a different messaging app:



1. Touch & hold the app's icon.
2. Touch  **App info** > **Notifications**.
3. Make changes.

Tip: In your phone settings, you can [prevent interruptions](#) by restricting text message notifications during hours you specify or from specific people.

Change text message reply to incoming calls

When your phone rings, you can drag  towards  to see a list of quick responses you can send by text message instead of [answering](#) the call.

To edit these quick responses:

1. Touch .
2. Touch  > **Settings**.
3. Touch **Quick responses**.

4. Touch one of the responses to edit it.

Get text messages on your computer



Set up Messages for web

If you use the  Messages app on your phone, you can see and send text messages on your computer.

Pair your computer and the  Messages app on your phone by scanning a QR code:

- The QR code is unique to that computer.
- You can set up multiple computers, getting individual QR codes, but only one is active at a time.

To set up a computer:

1. Be sure your phone and computer are connected to the internet.
2. On your phone, [open](#) the  **Messages** app and touch  > **Messages for web**.
3. On your computer, go to <https://messages.android.com>. To remember this computer and stay signed in to Messages, turn the slider on .
4. Follow onscreen instructions to scan the QR code on the web page with your phone.

Once paired, you'll see your latest conversations in your computer's browser.

See and send messages

When you have unread messages, you'll see a red notification and number of unread messages in the browser tab on your computer.

To send messages from your computer, your phone must be on and connected to the internet.



Usual carrier fees for sending text messages from your phone also apply to messages sent from your computer.

Sign out of Messages for web

If you don't use Messages on a paired computer for 14 days, you're automatically signed out from that computer for security reasons.

If you're using a shared or public computer, sign out when you're done.

To sign out from your phone:

1. [Open](#) the  **Messages** app.
2. Touch  > **Messages for web**.

3. Do one of the following:

- Touch  next to an individual computer to sign out of it.
- Touch **Sign out of all computers**.

To sign out from the computer, at the top of the message list, click .



Read, send, manage emails

Read email





If you've [set up email](#), you'll start receiving emails after your account [syncs](#) with your phone. When you receive an email [notification](#), you'll see  in the [status bar](#).

1. To open email from a notification, swipe the status bar down and touch the notification:
 - A single email notification opens the message directly.
 - A multiple email notification opens the email list; touch an email to open it.



If you dismiss the notification and want to view the email later, [open](#) the **Gmail** app.

2. Do any of the following:
 - To view other folders, touch  from your email list.
 - To learn about something mentioned in an open email, touch & hold . [Google Assistant](#) shows details, apps, and actions related to the email's contents.
 - Attachments appear at the end of the email. You can [view or save](#) them.
 - You can [print](#) emails from your phone.

Reply to or forward an email

1. Swipe to the end of the email to see all options:
 - To reply to the sender only, touch .
 - To reply to the sender and all recipients, touch .
 - To forward an email, touch .
2. Enter your message.
3. To copy someone on the email, in the To field, touch .
4. Touch .

Send new email

1. [Open](#) the **Gmail** app and touch .
Or, touch & hold , then touch **Compose**. (If you send lots of emails, add a [task shortcut](#). Drag **= Compose** to your home screen.)
2. Enter the recipient and your message.
3. To copy someone on the email, in the To field, touch .

4. Touch .

Add attachment to email

1. In the email you're composing, touch  > **Attach file**.
2. Browse to the file, and touch it to add it to the email. The attachment appears at the bottom of the email.

Find emails

When you open the Gmail app, you see your Inbox:

- To view sent email, drafts, recently deleted email, and other categories, touch .
- If you don't see emails listed after you touch a category, swipe down on the screen to sync it.

To search for emails, touch  at the top of your email list and enter search terms, like the topic or the sender's name.

Delete emails

To delete an open email, touch .

To delete multiple emails, go to your email list, touch & hold each message to delete, then touch .

To delete large quantities of email, sign into your email account on your computer, and see your email provider's help for more information.

Tips:

- To delete [attachments](#) that you saved from emails, use the Files app.
- You can also [remove](#) email accounts from your phone.

Learn more

For more help with Gmail, read [Google's support information](#).

For help managing email from other providers, sign into your email account on your computer and look for the provider's instructions.

View email attachments

View attachments

Attachments appear at the end of an [email](#).

To view or play the attachment, touch it.

If you see a message that you can't open the attachment type, most file types have a free viewer that you can use. In Play Store, search for the file type, then select and [download](#) an app.

Save attachments from email

To save an attachment, in the email touch  > **Save**.

To view saved attachments later, open the [Files](#) app.

Delete attachments saved from email

1. [Open](#) the **Files** app.
2. Touch **Browse** > **Downloads**.
3. Do one of the following:
 - To select one item, touch & hold it.
 - To select multiple items, touch & hold the first one, then touch the others.
4. Touch .

Prevent previews of attachments

Attached photos or videos appear as thumbnails, showing a preview.

To see a generic thumbnail instead of a preview thumbnail until you open the file:

1. Touch  > **Settings**, then touch the account name.
2. Uncheck **Download attachments**.

Preview inboxes from home screen

To preview your inboxes, open emails, or quickly start a new email, [add](#) the Gmail widget to your home screen.

With the widget, you can:

- **Open a message.** Touch the message.

- **Compose a message.** Touch .
- **View more messages.** Scroll down the list.
- **Open the Gmail app.** Touch the folder name at the top of the widget. Then you can view other folders, access email settings, and more.



Add email signature

To add a signature automatically to the end of emails you [send](#):

1. [Open](#) the **Gmail** app.
2. Touch  > **Settings**.
3. Select the account.
4. Touch **Mobile Signature** and edit the text you want to appear at the end of every email.

Control email notifications

You can control whether you see notifications when you [receive an email](#).

1. Touch & hold .
2. Touch  > **Notifications**.
3. Adjust notification settings.

Tip: To automatically silence notifications during hours you specify, use [Do Not Disturb](#) .

About the calendar

Keep track of upcoming events and get automatic reminders on your phone with your calendar. Google calendars let you save all your events in one place, which is secure, synced, and accessible from any web-enabled device or computer when you've signed in to your account.

You can:

- [Review](#) existing events.
- [Create](#) new events.
- [Control notifications](#) for events.

Your calendar can automatically create new events based on your incoming Gmail messages. For example, if you make restaurant reservations or book a flight, these events will show up automatically on your calendar; you don't have to add them.

If you created multiple calendars within your [Google account](#), or if you have multiple Google accounts on your phone, you can control which events are [synced](#) with your phone.

Find calendar events

Open calendar events

You'll see  in the [status bar](#) to alert you of upcoming events. Just swipe the status bar down and touch the notification to see the event details in your calendar.

To see your list of upcoming events, [open](#) the Calendar app.

Tip: For an overview of your upcoming events from your home screen, [add](#) a Calendar widget.

Get around the calendar



To glance at the month view:

1. Touch the month's name.
2. Touch a date to jump to it and see its events.

To change the view:

1. In your calendar, touch .
2. Touch **Schedule**, **Day**, **3 Day**, **Week** or **Month**. This view remains the default until you change it.



From these views, you can:

- **Read or edit event details.** Touch the event to open it and touch  to edit it.
- **Add new events.** Touch .
- **Search your calendar.** Touch  > **Search**.



Create and manage events

Create calendar events

As you're creating an event, you'll see suggestions for the event titles, locations, people, and more. In some cases, these suggestions are personalized based on information associated with your Google account and your previously created events.

1. **Open** the **Calendar** app and touch  > **Event**.
Or, touch & hold , then touch **New event**. (If you create lots of events, add a [task shortcut](#). Drag **= New event** to your home screen.)
2. Touch the account name to associate the event with the calendar you want.
3. Enter the start time and other details.
4. If you want a reminder sent to your status bar, touch **Add another notification** and select how long before the event you want a reminder.
5. Touch **Save**.

Edit or delete calendar events

1. Touch an event to open it.
2. Do any of the following:
 - To edit it, touch .
 - To delete it, touch  > **Delete**.

Control which events are shown

To temporarily hide calendar events for a Google account you don't need to see all the time:

1. Touch .
2. Beneath the account name, touch **Events**. If you have multiple calendars for that account, touch the name of each calendar to hide its events.



Tip: When you hide events, the calendar still [syncs](#) with your Google [account](#). To prevent that account's calendar from automatically syncing, from the home screen go to [Settings](#) > [Accounts](#).

To exclude automatically-generated events created from Gmail (for events such as flight bookings and restaurant reservations):

1. Touch  > **Settings** > **Events from Gmail**.
2. Under the name of the account, turn off **Add events from Gmail**.

To learn more, open Calendar and touch  > **Help & Feedback**.

Control notifications for calendar events





1. Touch & hold the  app icon.
2. Touch  > **Notifications**.
3. Adjust notification settings.

If you have [assigned](#) a ringtone for the notification but you silence your phone, your phone won't play the ringtone.

Tip: To automatically silence notifications during hours you specify, use [Do Not Disturb](#) .

Set alarms

Set alarm by touch

1. [Open](#) the **Clock** app.
2. Touch .
3. Do one of the following:
 - To create a new alarm, touch .
 - To use an existing alarm, switch it on.
 - To adjust an alarm's sound, schedule or label, touch .
4. To control general alarm settings, like alarm volume and snooze duration, touch  > **Settings**.

Set alarm by voice

1. If you've set up [Voice Match](#), say "OK, Google". Or, touch  on the Google Search widget.

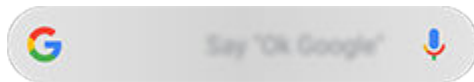

2. When prompted to speak, say your command. For example: "Set alarm for 7:45 p.m., label, switch the laundry" or "Wake me up at 7 a.m. tomorrow."



Your phone sets the alarm and provides a confirmation.

When an alarm is set

You'll see  in the [status bar](#) and on your [lock screen](#).

To adjust it, open [quick settings](#) and touch the alarm time.





Delete an alarm

1. [Open](#) the **Clock** app.
2. Touch .
3. Touch  > .

Use timer or stopwatch

Use timers





You can set multiple countdown timers with labels to keep track:

1. In the Clock app, touch  for the Timer tab.
2. Enter the time to count down.
3. Touch .
4. Do any of the following:
 - To pause the countdown, touch .
 - To add a label to the timer, touch **Label** (helpful when using multiple timers).
 - To add a minute to the countdown, touch **+ 1:00**.
 - To reset the counter to the original time, touch  > **Reset**.
 - To add a timer, touch **Add timer**.
 - To delete a timer, touch **Delete**.
 - To change the timer's sound, touch  > **Settings** > **Timer sound**.
 - If you leave this app, quickly return to it by swiping the status bar down with one finger to see the timer notification and remaining time. To open the timer, touch the notification.

Tip: If you use timers frequently, create a [task shortcut](#). Touch & hold , then drag **Create new timer** to your home screen.

Use a stopwatch

Record your time and share your results.



1. In the Clock app, touch  for the Stopwatch tab.
2. Touch .
3. Do any of the following:
 - To pause the stopwatch, touch .
 - To record laps (or multiple durations) while the stopwatch is running, touch **Lap**.
 - To reset the counter to zero, touch  > **Reset**.
 - To share your times with others or send them to yourself, touch  > **Share**.

- If you leave this app, quickly return to it by swiping the status bar down with one finger and touching a control. To open the stopwatch, touch the notification.

Tip: If you use stopwatches frequently, create a [task shortcut](#). Touch & hold , then drag **Start stopwatch** to your home screen.

Set date and time

Change time format

1. Go to [Settings](#) > **System** > **Date & time**.
2. To change how times are displayed:
 - To use military time such as 13:00, turn **Use 24-hour format** on .
 - To use 12-hour format such as 1:00 PM, turn **Use 24-hour format** off .

Set date and time automatically

1. Go to [Settings](#) > **Date & time**.
2. Turn on **Automatic date & time** and **Automatic time zone**.

Your phone automatically syncs with the local time (using the mobile network). The local time is used for alarms and is displayed on the lock screen and other displays.

Set date and time manually



1. Go to [Settings](#) > **Date & time**.
2. Turn off **Automatic date & time**.
3. To make corrections, touch **Set date** and **Set time**.

Switch time zones

1. Go to [Settings](#) > **Date & time**.
2. Turn off **Automatic time zone**.
3. Touch **Select time zone**. Then choose a regional time zone (which is applied to the current time).



Show multiple time zones

You can view multiple time zones in the Clock app, so you can coordinate plans with friends and co-workers in other cities, or stay in touch with family back home when you're traveling.

1. [Open](#) the **Clock** app and touch .
2. To add time zones, touch , then select cities in the time zone you want to view.

Show home time zone

When traveling, you can view your home time zone in the Clock app.

1. [Open](#) the **Clock** app and touch .
2. Touch  > **Settings** > **Automatic home clock**.
3. Touch **Home time zone**, then select your home time zone.

About the Moto app

Moto Actions

Use gestures as shortcuts for common tasks:

- Use three fingers to [take a screenshot](#).
- Twist your wrist twice quickly to open the camera from any screen.
- Remove the  navigation icons and use gestures with the [navigation bar](#) instead.
- Use the Volume buttons to [switch tracks](#) when listening to music.
- Make a [chopping motion](#) to turn the flashlight on or off.
- [Swipe to shrink screen](#) for one-handed use.
- Set your phone face down on a surface to start [Do Not Disturb](#) mode.
- [Pick up your ringing phone](#) to silence it and switch to vibrate.

Moto Display



See what's going on while your screen sleeps. Notification icons quietly appear and disappear on the screen, giving you a peek at [notifications](#) while using very little power.

Keep your screen on while you're looking at it with [Attentive Display](#) .

Shrink screen for one-handed use

You can temporarily shrink your screen to make it easier to use with one hand.

To enable this gesture:

1. [Open](#) the **Moto** app.
2. Touch  > **Moto Actions**.
3. Touch **Swipe to shrink** and turn it on .

To shrink any screen, swipe from the center down to the bottom left or right corner of the screen.

To return to a full-size screen, touch anywhere in the black area around the small screen.

Preview notifications when screen sleeps

About Moto Display notifications

When your screen sleeps, battery-friendly Moto Display notifications fade in and out, lighting only the pixels needed and showing notifications delivered since you last woke your screen. You can select which apps show notifications and limit content to control your privacy.

Moto Display does not show notifications:

- When the phone is in your pocket or purse
- When the phone is lying face down
- When you are on a call

Respond to Moto Display notifications

From the Moto Display screen, you can:

- **Preview a notification.** Touch & hold its icon.
- **Open the related app.** Drag your finger up to the preview (then unlock if using a screen lock).



- **Dismiss a notification.** Drag down to remove a notification.



- **Ignore for now.** Drag your finger to the right or left edge of the screen to stop notifications from flashing until the next one is delivered.



Change Moto Display settings

1. [Open](#) the **Moto** app.
2. Touch **≡** > **Moto Display** > **Peek Display**.
3. Do any of the following:
 - To stop specific apps from showing these notifications, touch **Block apps** > **+** and touch the app's name.
 - For more privacy when the screen is locked, touch **Level of details to show**.
 - To allow text or voice replies from the Moto Display screen without unlocking the phone, turn **Quick Reply** on **☑**.

Stop Moto Display notifications

1. [Open](#) the **Moto** app.
2. Touch **≡** > **Moto Display**.

3. Turn **Peek Display** off .

To restart the notifications, turn Peek Display on .

Share photos and videos

You can wirelessly share one, multiple, or all items from any Photos view, sending them as email or message attachments, uploading to the cloud, or using device-to-device connections like Bluetooth.

In addition to sharing wirelessly, you can [transfer photos to your computer](#) with a USB connection. You can also [move photos](#) from internal memory to SD card.

To share wirelessly:

1. [Open](#) the **Photos** app.
2. Navigate to the thumbnail of the item you want to share.
3. Select the item to share:
 - To select one item, touch & hold its thumbnail.
 - To select multiple items, touch & hold the first thumbnail, then touch the others to select them.

Tip: To clear all selections, touch .



4. Touch  and select the [way you want to share](#).

Upload photos and videos

Upload options

- Photos are stored at original size and count as part of your free storage on Drive.
- Photos are stored at standard size (2048px) after you reach the free storage limit. (You'll receive a message when you approach the limit and can purchase more space or delete unwanted files to continue uploading at original size.)
- Standard size photo uploads are unlimited and do not count as part of free storage on Drive.
- Video uploads are unlimited and do not count as part of free storage on Drive if they are less than 15 minutes long and 1080p or lower resolution.

Back up automatically

1. [Open](#) the **Photos** app.
2. Touch  > **Settings** > **Back up & sync**.
3. Turn **Back up & sync** on .

4. Adjust settings as needed:

- To choose high quality or original size for uploads, touch **Upload size**.
- To back up items in your Download, Screenshots, and third-party app folders, touch **Back up device folders**.
- To back up items over your cellular network, turn **Photos** and **Videos** on.
- To allow syncing when your cellular service is roaming, turn **Roaming** on .

Back up manually

Photos and videos that aren't backed up will have this icon . To manually back it up:

1. Open the photo or video.
2. On the photo or video, touch .

View your backed up photos and videos

From your phone, open the Photos app.

From your computer, sign in to photos.google.com.

More help

To learn more, open the Photos app and touch  > **Help**.

Answer calls

Answer incoming call

When you receive a phone call, the Incoming call screen shows the caller ID. If you miss a call, you'll see  in the [status bar](#).

To answer an incoming call:

- On the Incoming call screen, touch **Answer**.
- On the [lock screen](#), swipe  up to answer a voice call, or swipe the caller's icon/picture up to answer a video call.

During a call, you can use the keypad to enter numbers or codes, use speakerphone or a paired Bluetooth device, and add other people to the call. [Learn more](#).

Tip: You can [save a recent call](#) as a contact.

Dismiss incoming call

If you don't want to talk to the caller, you can:



- **Divert the call to voicemail.** On the Incoming call screen, touch **Dismiss**. Or, on the lock screen, press the Power button. You can also automatically [divert all calls](#) from a specified number to voicemail.
- **Respond with a text message.** On the lock screen, swipe  up. You can [customize](#) these default messages.
- [Block all calls](#) from that number.

Control ringtones and notifications

You can:

- **Quickly silence the ringer.** Press Volume Down on the side of the phone.
- **Silence ringtones during hours you specify.** Use [Do Not Disturb](#) .
- **Choose a unique [ringtone for specific people](#).** You'll know instantly who's calling.
- **Get notified of incoming calls when you're on a call.** Set up [call waiting](#).
- **Set the number of rings before sending a call to voicemail.** Dial into [voicemail](#), then follow your carrier's prompts to change this setting.





Fix a problem

If your phone isn't ringing for incoming calls, look for  in your status bar. Open [quick settings](#) and touch  to turn Do Not Disturb off. Your phone will ring for incoming calls. Check your [settings](#) to make sure your phone is screening calls at the appropriate times.

If you're having other problems, try these [troubleshooting steps](#).



Make calls

Make a call





1. Touch .
2. Touch  and enter a number.
3. If you enter a wrong number, touch .
4. Touch  to call the number.
5. To hang up, touch .



Other ways to make calls

You can place calls from:

- The  Phone app
- The  Contacts app
- Other apps that show contact information. Wherever you see a phone number, you can usually touch it to dial.

In the  Phone app, you can place calls in several ways.

To	Do this
Dial a number	Touch  , enter a number and touch  . If you enter a wrong number, touch  .
Dial by voice	Touch  and say a name or number. (If you don't see  , swipe down to close the dialer.) Or, skip the Phone app entirely and say a voice command .

Call by name Start typing the name in the  search box. You'll see a list of matches. Just touch one to call. (If you don't see , swipe down to close the dialer.)

Or, to see your contact list, touch . Swipe through and touch the person to call.

Call a favorite Touch the  tab.

Call nearby place Touch  and say or type the name, then touch the search result to place the call. [Learn more.](#)

Return call Touch , then touch  next to the number.

Tips:

- To call frequent numbers with one touch from your home screen, [add](#) a Direct dial widget.
- You can [save a recent call](#) as a contact.

Change default calling app

You can [download](#) additional calling apps from Play Store. After you've installed one, you can make it your default calling app.

1. Go to [Settings](#) > **Apps & notifications**.
2. Touch **Default apps** > **Phone app**.
3. Touch the app to use.

Fix a problem



To change your caller ID information seen by people receiving your calls, contact your carrier.

If you're having other problems, try these [troubleshooting steps](#).

During a call

Adjust sound during call

While listening, you can:

- **Adjust the volume.** Use the Volume button on the side of the phone.
- **Use speaker.** Touch .
- **Use a paired Bluetooth device.** Touch  to use or stop using the device.
- **Mute your microphone.** Touch . You can hear the caller but they can't hear you.

Enter a number

Touch  on the call screen to use the numeric keypad.

Use other apps

When you hold your phone to your ear, the screen goes dark to avoid accidental touches. To wake it up, move it away from your ear or press the Power button.

To hide the call and use other apps, touch .

To return to the call, swipe the status bar down and touch **Ongoing call**.

Answer call waiting

If [call waiting](#) is active and a new call comes in, you can answer it. Touch **Hold and Answer Voice**. The first call is put on hold.

To switch between calls, touch .

To merge the calls, touch .

End the call

Touch  on the call screen.

Or, swipe down from the top of any other screen to view the call notification and touch **Hang up**.

Fix a problem

If you're having problems, try these [troubleshooting steps](#).

Make video calls

Make video call with Duo app

Duo lets you video call anyone in your contact list who also uses Duo. Android users can get it from Play Store, and iPhone users can download it from the iTunes App Store. The video calls are secure and can't be seen by others.

To get started, [open](#) the Duo app and follow the onscreen instructions to set it up.





For more information, touch  > **Help & Feedback**.

Download video calling app

There are many video calling apps to choose from on Play Store (like WhatsApp, Skype, and more). Search for “video calls” in Play Store and [install](#) one of your choice.

Make conference calls

To make a conference call:

1. [Call](#) the first person.
2. To call the next person, touch , enter the number, then touch .
The first call goes on hold when you touch .
3. To join the calls after the second person answers, touch .

Block calls and SMS

About blocking

If you don't want to get calls or texts from a certain phone number, you can block it. When the number tries to contact you, your phone declines automatically.

You can still call or text a number you've blocked. But, you'll see **Blocked** on the listing in the Phone app and will get a warning in the Messages app, because you won't receive a response or a return call unless you unblock the number.

Block a number

Use either app to block both calls and texts from a number.



From the  Phone app:

1. Touch .
2. Touch a call from the number to block.
3. Touch **Block/report spam**.
4. If you don't want to report the call as spam to Google, remove the checkmark.
5. Touch **BLOCK**.

From the  Messages app:

1. Touch & hold the conversation thread from the number to block.
2. Touch .
3. If you don't want to report the call as spam to Google, remove the checkmark.
4. Touch **BLOCK**.

Block all numbers for a contact



1. Open the  **Contacts** app.
2. Touch the person's name.
3. Touch  > **Block numbers**.
4. If you don't want to report the call as spam to Google, remove the checkmark.
5. Touch **BLOCK**.

On the contact screen, you'll see  by the blocked numbers.



Unblock a number

If you reported a number to Google as spam when you blocked it, unblocking it also reverses the spam report.



From the  Phone app:

1. Touch  > **Settings** > **Blocked numbers**.
2. Touch  by the number to unblock.
3. Touch **UNBLOCK**.

From the  Messages app:





1. Touch  > **Blocked contacts**.
2. Touch  by the number to unblock.
3. Touch **UNBLOCK**.

From the  Contacts app:

1. Touch  > **Settings** > **Blocked numbers**.
2. Touch  by the number to unblock.

Identify and block spam callers automatically



For numbers that aren't in your contacts, Google can provide information about the number and warnings about potential spam callers.

1. Touch .
2. Touch  > **Settings** > **Caller ID & spam**.
3. Turn **Caller ID & spam** on .
4. To prevent ringing and notifications from suspected spam calls, turn **Filter spam calls** on .

You won't receive notifications for these calls, but you'll see them in your [call history](#) and can check any voicemail you receive.

When Caller ID & spam is on:



- If you see “Suspected spam caller” or “Spam” for an incoming call, you can answer the call or block and report the number.
- Your phone may need to send information about your calls to Google.
- It doesn't control whether your number shows when you make calls.

If you don't want Google to identify spam callers, touch  >  > **Settings** > **Caller ID & spam** and turn it off .

Turn on call waiting

When you're on a call and a new call comes in, the new call is sent to [voicemail](#). If you want to be notified of new calls instead, turn on call waiting.

Note: Some carriers automatically control call waiting. If you do not see this option on your phone, contact your carrier for more information.

1. Touch .
2. Touch  > **Settings**.
3. Do one of the following:
 - If your phone has one SIM card, touch **Calls**.



- If your phone has dual SIMs, touch **Calling accounts** and select the SIM.
4. Touch **Additional settings**, then check **Call waiting**.



When call waiting is on, if you're on a call and a new call comes in, you can answer it. The first call is put on hold. Touch  to merge the two calls.

View and delete call history

See your call history



To see all recent calls:

1. Touch .
2. Touch .
3. You'll see one or more of these icons next to each call:

Icon	Meaning
	Missed call (incoming)
	Call you answered (incoming)
	Call you made (outgoing)

4. To learn more about a call, touch it, then touch  **Call details**.



To see only your missed calls:

1. Touch .
2. Touch  > **Call History**.
3. Touch **Missed**.

Save recent call as contact

You can save a number to make it easy to find and call back later.

To save a number:





1. Touch .
2. Touch .

3. Touch the number.
4. Do one of the following:
 - To add to an existing contact, touch **Add to a contact**.
 - To set up a new contact, touch **Create contact**. Add contact details.
5. Touch  or **Save**.



Delete calls from history

Caution: There's no way to restore the history after you delete it.

To delete one call:

1. Touch .
2. Touch .
3. Touch the number.
4. Touch  **Call details**.
5. Touch .

To delete all calls:



1. Touch .
2. Touch  > **Call History**.
3. Touch  > **Clear call history**.

Add contacts



Add contacts automatically

When you [add an account](#), such as Google or email, to your phone, the contacts for that account are available on your phone automatically.

Add contact with Contacts app

1. [Open](#) the  **Contacts** app.
2. Touch .
3. The account that will be [synced](#) with your new contact appears at the top. To change this or to view more fields, touch **More Fields**.
4. Touch a text box to type the name and details. Fill in as much or as little information as you'd like.



Tips:

- To add a photo, touch . Choose a photo you've saved, or take a photo and crop it.
- You can assign a [custom ringtone](#) for calls from that contact.
- If you have multiple [accounts](#) on your phone and want to change the default account for new contacts, go to **Contacts** >  > **Settings** > **Default account for new contacts**.

5. Touch **Save**.

Add contact from text message

You can easily create a new contact or add a new number for an existing contact when you receive a text message from an unassigned number.

1. [Open](#) the  **Messages** app.
2. In the message list, touch & hold the number, then touch .
3. Touch **Add Contact**.
4. Do one of the following:
 - To add to an existing contact, touch the contact's name.
 - To set up a new contact, touch **Create contact** and add contact details.
5. Touch .







Other ways to add contacts

- [Save a recent call](#) as a contact.
- Have someone send you a [name card](#).
- Have someone beam you the contact with [NFC](#).
- [Scan](#) business cards or QR codes.

Edit or delete contacts

Edit contacts



After creating a contact, you can change the name, photo, and other contact information.

1. [Open](#) the  **Contacts** app.
2. Touch the person's name.
3. Adjust settings as needed:
 - To assign a [custom ringtone](#), touch  > **Set ringtone**.
 - To send calls directly to voicemail, touch  > **Route to voicemail**. You can also [block calls](#).
 - To edit contact info, touch , then touch a field to make changes, touch  to change the photo, or touch  > **Discard** to undo changes.
4. Touch .



Merge contacts

If you have two contacts for the same person, you can merge the information (including all emails and phone numbers) into a single listing.

To automatically merge contacts:

1. [Open](#) the  **Contacts** app.
2. Touch  > **Suggestions**.
If you don't see **Suggestions**, no duplicate contacts were found.
3. Touch **Merge duplicates**.
If you don't see this option, contacts can't be automatically merged.
4. Select options to merge one or all duplicates.



To manually merge contacts:

1. [Open](#) the  **Contacts** app.
2. Touch & hold the primary contact to merge.
By default, this contact's name is used for the new listing.
3. Touch the second contact.
4. Touch  > **Merge**.

Tip: You can edit the primary contact name (for the merged listing), or delete or change other contact information as needed.

Delete contacts

You can delete contacts created and stored on your phone. If the contact is synced from a social network account, you need to delete the contact in that account. For example, a Facebook contact must be deleted from within your Facebook account. Or, hide Facebook contacts on your phone by [filtering](#) your contact list.

1. [Open](#) the  **Contacts** app.
2. Touch the name of the person.
3. Touch  > **Delete** and confirm the deletion.

Star your favorite contacts

Contacts you mark as favorites appear at the top of the list in the Contacts app and on the  tab in the Phone app.

To add someone to your favorites:

1. Touch the contact icon (photo or other icon).
2. Touch .



Sort contacts

Sort contacts in Contacts app

1. [Open](#) the **Contacts** app.
2. Touch  > **Settings**.
3. Set options:

- To sort by first or last name, touch **Sort by**.
- To list names with first name first or last name first, touch **Name format**.



Sort contacts in Phone app





1. Open the  **Phone** app.
2. Touch  > **Settings** > **Display options**.
3. Set options:
 - To sort by first or last name, touch **Sort by**.
 - To list names with first name first or last name first, touch **Name format**.

Narrow which contacts are shown

In the Contacts app, you can narrow which contacts are shown. These changes don't affect which contacts are shown in the Phone app.

In the  **Contacts** app, choose one:

- To show contacts from only one account, touch . Then touch  and select the account.
- To show contacts from all accounts, touch  > **All contacts**.

In the  **Phone** app, use the  tab to see only contacts you call frequently. To remove contacts from this tab, touch  on the contact, then touch .

Share contacts



Ways to share contacts

You can share [one](#) or [all](#) contacts with someone by sending a name card file (.vcf).



You can also share a contact's information as a [text message attachment](#).

Or, just touch your phones together and beam the contact information with [NFC](#).

Share one or a few contacts

1. Open the  **Contacts** app.
2. Touch & hold a name to select it, then touch others to select more.
3. Touch .
4. Select the [way to share](#).

Export all contacts

1. [Open](#) the  **Contacts** app.
2. Touch  > **Settings** > **Export**.
3. If you use more than one account, select the account.
4. Touch **Export to .vcf file**.
5. Touch **SAVE** to save it in your Download folder.
6. Open the **Files** app.
7. Touch **Browse** > **Download**.
8. Touch & hold the file.
9. Touch .
10. Select the [way to share](#).



Receive a name card file

1. When someone sends you a name card file, you'll see a file transfer notification. Touch the [notification](#) and accept the file transfer.
2. Touch the name card file (.vcf) to open it and add the person to your contacts.

Use voicemail

Listen to voicemail

If you've [set up voicemail](#), you'll see  in the [status bar](#) when a new voicemail message arrives.

1. Do one of the following:
 - [Swipe the status bar down](#) and touch .
 - Or, touch , then touch & hold 1.
2. When connected, follow your carrier's system prompts.

If you listen to a new message and disconnect from voicemail without saving or deleting it, you will still see  in the status bar.

Manage your mailbox

Your carrier provides your voicemail system. Dial into voicemail and follow the prompts to manage your messages and mailbox.



Contact your carrier for help with:

- Recovering or resetting voicemail password/PIN
- Replaying messages
- Saving, forwarding, or deleting messages
- Replying with or sending voice messages
- Changing number of rings before connecting call to voicemail
- Changing greeting or recorded name
- Changing notification options
- Changing mailbox language

Fix a problem

If  remains in your status bar after you listen to your voicemails, try the following.

First, force stop the app:

1. Touch & hold .
2. Touch .
3. Touch **Force stop**.



This restarts the app and should remove the notification.

If that doesn't help:

1. Call yourself from another phone and leave a short message.
2. Go into to your voicemail and delete this message, but wait to hang up until the notification icon has disappeared from your status bar.

Send all calls from contact to voicemail

To send all calls from a certain person to voicemail:











1. [Open](#) the  **Contacts** app.
2. Touch the contact's icon.
3. Touch  > **Route to voicemail**.

Tip: You can also [block](#) all calls and text messages from a number.

Listen to radio

Listen to FM stations

Your phone automatically tunes to radio stations with the best signal. Listening to the radio doesn't use your mobile data.

1. Plug headphones (any brand) into your phone. They serve as a radio antenna. Even when you listen through your phone speakers, [Bluetooth](#) wireless speakers, or wireless headphones, the wired headphones still serve as your antenna.
2. [Open](#) the **FM Radio** app.
3. Do any of the following:
 - To view all stations and listen to any, use the  tab.
 - To listen to your favorite stations, use the  tab.
 - To seek stations throughout the radio dial, touch the  tab, then touch  or . Tune to specific frequencies by dragging the tuner to the appropriate number.
 - To change between headphones or speakers, touch  or .
 - To listen to the radio while using another app, touch . Use the mini player in notifications to seek stations or turn it off. Touch the notification to open the full app. To remove the notification, touch  to turn off the radio.
 - To turn the radio off, touch .

Tip: If you're having reception issues, try moving your phone as far from the headphones as possible to increase the size of the antenna. Or, try moving a short distance, towards a window if you are inside or away from buildings if you are outside.



Manage your favorite stations

To add a station to your favorites, on the  or  tabs, touch  by the station.

To listen to your favorite stations, use the  tab.

To remove a favorite, on any tab, touch  by the station.

Record current station

1. On the  tab, touch  to start recording.
2. To stop recording, touch .
3. If desired, edit the recording's name.

4. Touch **DONE**.

To listen to a recording, touch  > **Recordings** > .

To delete or rename a recording, beside it, touch .

To delete all recordings, at the top of the screen, touch  > **Delete all**.



To change storage location for recordings, touch  > **Settings** > **Storage location**.

Maintain volume when notification arrives

To prevent the radio volume from being lowered when a notification arrives:

1. Touch  > **Settings**.
2. Touch **When a notification is played** > **Keep volume**.

Set sleep timer for radio

1. Touch  > **Sleep Timer**.
2. Select a duration of time to listen.
3. Touch .

After the specified time, the radio automatically turns off.

To turn off the timer before the duration has passed, touch  in the app, its notification, or on the lock screen.

Listen to music

Get music





Stream songs or download them to your phone so you can listen when you're on an [airplane](#) or don't have an internet connection.

Your phone can play MP3, FLAC, M4A, AAC, AAC+, MIDI, and WAV files.

To get music, do any of the following:

- Purchase it in an app, like Play Music. Then stream it or download it using that app.
- Transfer it over [USB](#) or [Bluetooth](#) from your computer to your phone's Music folder.
- [Upload it](#) from your computer to the cloud and listen on any internet-connected device.

Listen with Play Music



1. [Open](#) the **Play Music** app.
2. Do any of the following:
 - To play music stored on your phone, on your SD card, or in the cloud, touch  > **Music library**.
 - To prevent streaming and listen only to music stored on your phone, touch  and turn **Downloaded only** on .
 - To change the storage location for downloaded files, touch  > **Settings** > **Storage Location** and choose **Internal** for device storage or **External** for SD card storage.
 - To learn more about features or music pricing, touch  > **Help & Feedback**.

To open your music library with one touch from your home screen, add a [task shortcut](#):

1. Touch & hold .
2. Drag **My library** to a blank space on your home screen.

You can listen through your phone's [speaker](#) or by [pairing with a Bluetooth speaker](#).



Listen with other apps

You can [download apps](#) for listening to and organizing music. Open the new app and touch  or  > **Help** to learn more.

Use Volume buttons to switch tracks

When the screen is off, you can use the [Volume buttons](#) to switch tracks.

To set it up:

1. [Open](#) the **Moto** app.
2. Touch  > **Moto Actions**.
3. Touch **Media controls** and turn it on .

To switch tracks when the screen is off:

- For the next track, press & hold the Volume up button.
- For the previous track, press & hold the Volume down button. If this restarts the current track, press Volume down again.

Transfer music files

About transferring music

You can transfer purchased music files stored on your devices between devices you own.

Music apps that share music files from cloud storage typically share links to access stored files instead of transferring music files between devices. To transfer music files, the music must be stored on the device.

Send files over Bluetooth

To send music files stored on your phone:

1. [Pair your phone](#) with the device receiving the music.
2. On your phone, open the **Files** app and touch **Browse > Audio**.
3. Touch & hold the file.
4. Touch  and select **Bluetooth**.
5. Touch the name of the paired device.

During file transfer, you'll see  in the status bar. To check the status, [see](#) the notification.

Receive files over Bluetooth

1. [Pair your phone](#) with the device sending the music.
2. On the device sending the music, start the file transfer, following device's instructions.
3. When you receive the Bluetooth notification on your phone, swipe down and touch it, then touch **Accept**.

During file transfer, you'll see  in the status bar. To check the status, [open](#) the notification.

The files are saved in Music/Bluetooth, where music apps will find them. You're ready to [listen](#)!

Tip: To see Bluetooth files you received, go to [Settings](#) > **Connected devices** > **Connection preferences** > **Received files**.

Transfer music from your computer

To move your music from your computer to your phone, [connect them with a USB cable](#) and copy the files to your phone's Music folder.

Connect a MIDI device

To connect a MIDI device:

1. Make sure you have:
 - A USB cable that's capable of data transfer and isn't for charging only.
 - A USB OTG adapter cable, if needed.
2. Turn the phone and MIDI device on.
3. Connect them with the USB cable (and adapter if needed).
4. Unlock the phone.
5. Change the USB connection type to allow MIDI connection:
 1. Swipe down from the top of your home screen and touch the  **Charging this device via USB** notification.
 2. Touch **MIDI**.

Charge phone

How to charge phone

Your phone is like a small computer, giving you tons of information and apps. Depending on what you use, that can take a lot of power. Plan on charging the phone each night so it's ready for the next day.

1. Using the charger that came with the phone, insert the USB end into the phone.

Weaker chargers take longer to charge the phone, and if you use the phone while charging, may not charge it at all.

2. Insert the plug into an electrical outlet.

When the phone is off and charging, you'll see the outline of a battery and a percentage. If the battery is completely discharged, this will not appear until the phone has received the minimum voltage required to boot.

When the phone is on and charging, you'll see  in the [status bar](#).

Tips for charging phone

- You can use your phone while charging. To charge faster, don't use your phone while charging.
- If you can't turn the phone on while it's charging, wait until it receives enough voltage before turning it on.
- When the battery gets low, the phone sends a [notification](#).
- Use [Battery Saver mode](#) when the battery is low.
- You can [turn off](#) charging sounds.

Fix a problem

If you're having problems, try these [troubleshooting steps](#).

Extend battery life

Choose settings that use less battery

To get the most life from your battery:

- **Connections:** Turn off [Bluetooth](#) and [GPS](#) when you're not using them.
- **Wi-Fi:** Turn on [Wi-Fi](#) when the phone is in a location with Wi-Fi coverage.

- **Screen:** Turn down screen brightness and set a shorter [screen timeout](#).
- **Sync:** If you don't need it, turn off [automatic syncing](#) for all accounts. This means you won't receive notifications when updates occur and you'll need to manually sync to get new emails.

Temporarily conserve battery power

Use [Battery Saver](#) mode to keep going on a low battery.

Also, avoid these battery-intensive activities until you can [charge](#):

- Recording or watching videos
- Listening to music
- Taking pictures
- Using Live (animated) [wallpaper](#)

See what's using your battery

To see if a specific app is draining your battery:

1. Go to [Settings](#) > **Battery** > **Usage details**.
2. Swipe up to view the list of apps and features using power since the last full charge.
3. Touch the app or feature using a lot of power.
4. Under **Manage battery usage**, touch options for reducing the power usage.

Keep adaptive battery and battery optimization on

To ensure that apps use your battery only when they need to, keep adaptive battery and battery optimization on.

Check that adaptive battery is on for your phone

When you keep adaptive battery on, infrequently used apps will run less when you're not using them. Your phone will learn how you use apps over time and adjust for best battery life.

1. Go to [Settings](#) > **Battery** > **Adaptive Battery**.
2. Turn **Use Adaptive Battery** on .

Check that battery optimization is on for each app

If you turn off Battery optimization for an app, that app can run when you're not using it, even when Adaptive Battery is on. This decreases battery life unnecessarily.

1. Go to [Settings](#) > **Apps & notifications** > **Advanced** > **Special app access**.
2. Touch **Battery optimization**.

3. If an app is listed as **Not optimized**:
 1. Touch the app.
 2. Touch **Optimize > Done**.

Use Battery Saver mode

Battery Saver helps you keep going on a low battery by automatically restricting mobile data until the next charge. Some apps and services won't work unless you're connected to a Wi-Fi network.

To turn Battery Saver on, open [quick settings](#) and touch .

To turn Battery Saver on automatically when your power is below a specified level:

1. Open quick settings, then touch & hold .
2. Touch **Battery Saver > Turn on automatically**.
3. Move the slider to adjust the percentage when Battery Saver switches on.

When the phone is in Battery Saver mode, you'll see  in the status bar.

About storage options

Phone internal storage

You can store photos, videos, music, and applications on your phone. Files you [download](#) from email or the internet are stored there, too.

You can [free up space](#) when needed.

Using SD card as portable storage

Use your SD card as portable storage if you:

- Frequently swap your SD card and content between devices
- Have a Class 2, 4, or 6 card
- Don't download and install many large apps

When used as portable storage:

- The card can only store media files.
- The card is readable by other devices, including phones, computers, cameras.
- Content on the card isn't encrypted.
- You can view or listen to media on the card using media apps.
- You can set the Camera app to store new photos and videos on the card.
- Apps can't be moved to or installed on the card.

To transfer files or view them on another device (TV, computer, etc.), [remove](#) the card from your phone and insert it into the other device. You can also [move files](#) from internal memory to the card, or [transfer files to a computer](#) using a USB cable.

Using SD card as extended internal storage

Use your SD card as internal storage if you:

- Need more device storage and plan to keep the card in the phone
- Download large apps and games
- Have a high-speed card (UHS-1)

When used as internal storage:

- The card can be your phone's primary storage.
- You can move downloaded apps, app data, and media files to the card.

- The card is NOT readable by other devices, is always encrypted, and cannot be decrypted on any other device.
- If you decide to change the card to portable storage, the card must be formatted and erased.

Cloud storage

Clouds are great for storing files you want to share and access on the go, like [photos](#), [videos](#), and [music](#).

Benefits include:

- Access to your files from any computer or mobile device with an internet connection - uses cellular data or Wi-Fi
- File synchronization - no need to keep track of multiple versions in multiple storage locations
- Ideal for backups of photos and videos

Cloud storage providers typically offer free storage that can be expanded with a paid subscription once you reach the free-storage limit. Or you can manage your free storage by removing files you no longer need to make space for new ones.

Apps like Drive and Photos let you easily [back up media](#).

Manage phone storage

Free up space by scanning



To scan your phone for old and unused items to remove, like downloads and unused apps:

1. [Open](#) the **Files** app.
2. Touch **Clean**.

You'll see suggestions for categories of items to check and free up space.

3. Touch the suggestions and follow onscreen instructions to uninstall, move, or delete items.

If you don't see suggestions to free up space, check that suggestions are on:

1. [Open](#) the **Files** app.
2. Touch  > **Settings**.
3. Touch **Notifications** and turn on  ones you want to receive.

Free up space manually

To free up space:

1. [Open](#) the **Files** app.
2. Touch **Browse**.
3. Touch a category (apps, images, videos, etc.) to view that type of item.
4. Do any of the following:
 - To uninstall apps, touch the app name, then touch **Uninstall**.
 - To clear an app's cache, touch the app's name, then touch **Storage > Clear cache**.
 - To clear your data for an app, touch the app's name, then touch **Storage > Clear storage**.
 - To delete media or other files, touch & hold to select one or more items, then touch .

Schedule automatic removal of photos and videos

If you [automatically back up](#) your photos and videos, you can automatically remove copies from your phone's internal storage after 30, 60, or 90 days.

1. Go to [Settings](#) > **Storage**.
2. If you installed an SD card, touch **Internal shared storage**.
3. Touch **Storage manager** and turn it on .
4. Touch **Remove photos & videos** and select a duration.

If you store photos or videos on your SD card, this does not delete them.

Manage SD card

Move media from phone to SD card

To free up internal storage on your phone:

1. [Open](#) the **Files** app.
Or, go to [Settings](#) > **Storage** > **Internal storage** > **FREE UP SPACE**.
2. Touch **Clean**.
If there are media files to move, you'll see them listed.
3. Touch **Move to SD card**.
4. Select items to move.

5. Touch **Move**.

Remove SD card

Drag the SD card notification down, and touch **Eject**.

If you don't see the notification:

1. Go to **Settings** > **Storage**.
2. Next to your SD card name, touch .

It's now safe to [remove the card](#) from the phone.

To insert the card into another device (computer, projector, etc.), you may need the adapter that came with your card. See device manufacturer's instructions for the type of adapter required and insertion instructions.

Erase SD card

1. Go to **Settings** > **Storage**.
2. Select your SD card.
3. Touch  > **Storage settings** > **Format**.
4. Touch **Erase & format**.
5. Touch **Done**.

Change storage type

You'll need to choose one of two formats for your SD card. [Need help deciding which format to use?](#)

1. Go to **Settings** > **Storage**.
2. Touch the SD card's name.
3. Touch  > **Storage settings**.
4. Touch **Format as internal** or **Format as portable**.



Find downloaded files

You can download files and store them on your phone, including:

- Photos, videos, and documents you save from emails or texts
- Books, movies, or other content that you buy from Play Store and save for offline viewing
- Other files or images you download from the web

When the file has finished downloading, you'll see  in the [status bar](#). Touch the [notification](#) to open the file in the appropriate app.

To view, edit, or delete downloads:

1. [Open](#) the **Files** app.
2. Touch **Browse > Downloads**.
3. Do any of the following:
 - To open or play a file, touch it.
 - To sort files by name, date modified, or size, touch  > **Sort by**.
 - To share a file, touch & hold it, then touch .
 - To delete a file, touch & hold it, then touch .

Tip: To access downloads from a computer, connect your phone with a [USB cable](#). Then open the phone's internal storage, and look for files in the Downloads folder.

Recover recently deleted files

You can try to recover recently deleted photos, videos, or texts. But do so as soon as possible. The more you use the phone, the more likely the file will be overwritten with new data.

1. Search for “file recovery” in Play Store and [install](#) one of the apps.
2. Use the app to scan your phone.
3. If you can't recover recently deleted items, try connecting your phone to your computer with a USB cable and using a desktop program for file recovery.

Tip: [Back up your photos to the cloud](#) so you won't lose them if you delete them from your phone.

Upload music to cloud

You can store up to 20,000 songs from your library in the cloud, for free, with Google Play Music (not available in all countries). Then you can instantly listen to your tunes wherever you are.

You can upload music from your:

- iTunes library

- Windows Media Player library
- My Music folder, or any folder on your computer

To upload your music, use Google Play Music for Chrome or install the Music Manager application on your computer. On your computer, visit play.google.com/music and click  > **Upload music**. To learn more, read [Google's help](#).

After you've uploaded your music, you can listen to it:



- On your computer by visiting www.google.com/music
- On your phone with the [Play Music](#) app

Upload photos and videos

Upload options

- Photos are stored at original size and count as part of your free storage on Drive.
- Photos are stored at standard size (2048px) after you reach the free storage limit. (You'll receive a message when you approach the limit and can purchase more space or delete unwanted files to continue uploading at original size.)
- Standard size photo uploads are unlimited and do not count as part of free storage on Drive.
- Video uploads are unlimited and do not count as part of free storage on Drive if they are less than 15 minutes long and 1080p or lower resolution.

Back up automatically

1. [Open](#) the **Photos** app.
2. Touch  > **Settings** > **Back up & sync**.
3. Turn **Back up & sync** on .
4. Adjust settings as needed:
 - To choose high quality or original size for uploads, touch **Upload size**.
 - To back up items in your Download, Screenshots, and third-party app folders, touch **Back up device folders**.
 - To back up items over your cellular network, turn **Photos** and **Videos** on.
 - To allow syncing when your cellular service is roaming, turn **Roaming** on .

Back up manually

Photos and videos that aren't backed up will have this icon . To manually back it up:

1. Open the photo or video.
2. On the photo or video, touch .

View your backed up photos and videos

From your phone, open the Photos app.

From your computer, sign in to photos.google.com.









More help

To learn more, open the Photos app and touch  > **Help**.

Scan documents and make copies

Scan document to Drive

You can scan important documents with your phone and save them as PDFs on Google Drive.

1. [Open](#) the **Drive** app.
2. Touch  > .
3. Align your phone over the document to scan and touch .
4. Optionally:
 - Touch  to crop.
 - Touch  to select image enhancement options.
 - Touch  to delete, rename, and adjust image and PDF settings.
 - Touch  to reset the scanner (deletes current unsaved scan).
 - Touch  to add another page.
5. When you've finished scanning, touch .

The PDF is saved on Drive. In Drive, open the file and touch  to share or [print](#) the scan.

Tip: You can also use the Camera app to [scan information](#).

Scan and save to folders from your home screen



Add Drive Scan widgets to your home screen to scan and save to new or selected folders. Each widget saves to a single folder on Drive. So, [add multiple widgets](#), one for each folder you need (receipts, billing statements, recipes, etc.).

Connect with Wi-Fi

Connect to Wi-Fi network

Some Wi-Fi networks are open and you can simply connect your phone to them for internet access. Other Wi-Fi networks are secure and require you to enter a password or digital certificate. Contact the Wi-Fi network's owner or administrator for the password or digital certificate.

To search for and connect with available Wi-Fi networks:

1. Open [quick settings](#), then touch & hold .
2. Turn **Use Wi-Fi** on .
3. Touch the Wi-Fi network you want to connect to.
4. If the network is a secure one, enter the password.

Tip: Make sure you enter the password correctly. Touch **Show password** to see what you're typing.

When your phone is connected, you'll see  in the [status bar](#). If the connection is poor,  appears in the status bar.

Reconnect with Wi-Fi network

Open [quick settings](#) and touch the icon if Wi-Fi is not already on. Your phone automatically connects to a previously-connected Wi-Fi networks when you're in range.

To connect to a different network, touch & hold , then choose another network.

Turn Wi-Fi off

To extend the life of your battery between charges, turn off Wi-Fi when you're not in a location with access to Wi-Fi.

Open [quick settings](#) and touch  to turn it off.

Advanced: Forget Wi-Fi connection

1. Open [quick settings](#), then touch & hold .
2. Touch the network's name and touch **Forget**.

Advanced: Disable Wi-Fi scanning

1. Go to [Settings](#) > [Security & location](#).

2. Touch **Location** > **Advanced** > **Scanning**.
3. Turn **Wi-Fi scanning** off .

Fix a problem

If you're having problems with Wi-Fi, try these [troubleshooting steps](#).

Use Airplane mode

Airplane mode turns off all wireless connections, preventing your phone from transmitting signals that could interfere with airplane communications.

Open [quick settings](#) and touch  to turn airplane mode on. This disables all wireless connections (Wi-Fi, voice and data for calls and text messages, Bluetooth). If permitted by your airline, you can then turn [Wi-Fi](#) and/or [Bluetooth](#) back on during the flight. Other wireless connections remain off.

Control data usage

Turn mobile data off/on

To toggle it on/off, swipe the [status bar](#) down and touch .



When you turn off data usage over your cellular network, you can still use data by connecting to a [Wi-Fi network](#).

Cellular data must be ON if you want to:

- Receive or send [multi-media messages](#)
- [Share your phone's internet connection](#) with other devices

Set data limit

Sometimes it's easy to exceed your data plan limit without realizing it. To avoid surprises, set a usage warning that notifies you when you're close to your limit, and set a usage limit that turns off cellular data when the limit is reached.

1. Go to [Settings](#) > **Network & internet** > **Data usage**.
Or, open [quick settings](#), then touch & hold .
2. Touch **Data warning & limit**.
3. To set a warning, turn **Set data warning** on , then touch **Data warning** and enter the amount of data.

4. To set a usage limit, turn **Set data limit** on , then touch **Data limit** and enter the amount of data.



Restrict background data

Even when you're not using them, most apps sync data in the background.



You can prevent specific apps from ever sending or receiving data in the background. Also, if you're running low on data during your billing cycle, use Data Saver to conserve your remaining data. Data Saver lets you quickly turn off background data usage for **all** apps; if you have one or two that want to continue using background data, you can set them as exceptions.

When you restrict background data, you will not receive notifications from apps that typically **sync** in the background (like Gmail) until you open the app; then data syncs as usual.

If you're running low on data during your billing cycle:



1. Go to **Settings** > **Network & internet** > **Data usage**.
Or, open **quick settings**, then touch & hold .
2. Touch **Data Saver** and turn **Use Data Saver** on .

You'll see  in your status bar and all apps are prevented from using background data.

Tip: The first time you turn Data Saver on,  is added to **quick settings**. After that, just swipe the status bar down and touch  to turn Data Saver off/on.

3. To allow certain apps to continue using background data, touch **Unrestricted data**, then next to the app name, slide the switch on .

To prevent specific apps from ever using background data:

1. Go to **Settings** > **Network & internet** > **Data usage**.
Or, open **quick settings**, then touch & hold .
2. Touch **App data usage**.
3. Touch an app, then turn **Background data** off .

Restrict background data for Wi-Fi networks

If you have to pay for data usage on a Wi-Fi network, you can restrict apps from using background data on that network.

1. Go to **Settings** > **Network & internet** > **Data usage**.
Or, open **quick settings**, then touch & hold .
2. Touch **Network restrictions**.

3. For each Wi-Fi network where you pay for data usage, slide the switch on  to indicate it is a metered Wi-Fi network.

Any restrictions that you set up on background data for cellular networks will also apply for these metered Wi-Fi networks.

Dual SIMs

If your phone has two SIMs, cellular data is active on only one SIM at a time. You can [control](#) which SIM is used.

Share your internet connection

About hotspots and tethering

Want to use the internet on a laptop computer or tablet but don't have a connection? You can share your phone's cellular data connection with multiple devices by turning your phone into a Wi-Fi hotspot. You can also share your internet connection with a single device using USB tethering or Bluetooth tethering.

Note: Your cellular plan must support data sharing. If you don't know, contact your carrier.

Set up Wi-Fi hotspot



1. Check that [cellular data is on](#). If cellular data is off, your phone doesn't have an internet connection to share.
2. Go to [Settings](#) > [Network & internet](#) > [Hotspot & tethering](#).
3. Touch **Wi-Fi hotspot** and do any:
 - To make it easier to identify your hotspot when connecting to it, change the network name for your hotspot.
 - To prevent others from seeing your phone's network name, check **Hide my device**.
 - To see the current password, touch **Advanced** > **Hotspot password**.
 - If the hotspot signal is experiencing interference, touch **Advanced** and change the broadcast channel/band to 5GHz. If the hotspot signal seems weak, change it to 2GHz. (This feature is not available in all countries.)

Connect devices to Wi-Fi hotspot

1. Check that [cellular data is on](#). If cellular data is off, your phone doesn't have an internet connection to share.

2. Go to **Settings** > **Network & internet** > **Hotspot & tethering**.
3. Touch **Wi-Fi hotspot** and turn it on , then plug in your phone to charge. Using the hotspot really drains the battery!

When your hotspot is active, you'll see  in the **status bar**.

Tip: The first time you turn the hotspot on,  is added to **quick settings**. After that, just swipe the status bar down and touch  to turn the hotspot off/on.

4. To connect a device, open the device's Wi-Fi settings, select your phone's hotspot and enter the hotspot password.

To disconnect devices from your hotspot, touch **Wi-Fi hotspot** and turn it off. When you turn it back on, devices with the password can connect automatically. To prevent this, change the Wi-Fi password.

Manage Wi-Fi hotspot connections

By assigning a password when you **set up** your hotspot, you ensure that people can't connect to your hotspot without your knowledge or permission.

To disconnect all devices and prevent users from reconnecting:

1. Turn the hotspot off.
2. **Change** the password.
3. Turn the hotspot back on to continue using it.

Tip: When no devices are connected, the hotspot turns off automatically. To adjust this setting, go to **Settings** > **Network & internet** > **Hotspot & tethering** > **Wi-Fi hotspot** > **Advanced** > **Turn off hotspot automatically**.

Change Wi-Fi hotspot password

1. Go to **Settings** > **Network & internet** > **Hotspot & tethering**.
2. Touch **Wi-Fi hotspot**.
3. Touch **Advanced** > **Hotspot password** to see the current password.
4. To change the password, type over the current password.

Note: Although you can turn off passwords for your hotspot, keeping a password prevents unauthorized usage of your cellular data.

USB tethering

To connect a device to the internet using your phone's cellular data and a USB cable:

1. Check that [cellular data is on](#). If cellular data is off, your phone doesn't have an internet connection to share.
2. Connect your phone to your computer with a USB cable.
3. On your phone, go to [Settings](#) .
4. Touch **Network & internet > Hotspot & tethering**.
5. Turn on **USB tethering** to start the connection.

You'll see  in your [notifications](#).

To stop the connection, touch the notification and turn off **USB tethering**, then disconnect your phone and computer.

Bluetooth tethering

To connect a device to the internet using your phone's cellular data and a Bluetooth connection:

1. Check that [cellular data is on](#). If cellular data is off, your phone doesn't have an internet connection to share.
2. Turn on Bluetooth on your phone and [pair](#) with the other device.
3. Set up the other device to get its network connection via Bluetooth.
4. On your phone, go to [Settings](#) .
5. Touch **Network & internet > Hotspot & tethering**.
6. Turn on **Bluetooth tethering** to start the connection.

You'll see  in your [notifications](#).

To stop the connection, touch the notification and turn off **Bluetooth tethering**.

Fix a problem

If you're having problems, try these troubleshooting steps:

- [Wi-Fi hotspot](#)
- [USB](#)
- [Bluetooth](#)

Connect to VPNs

A virtual private network (VPN) lets you access files on a secure network like an office network with a firewall. Contact your network administrator for VPN settings and any additional apps or requirements.

To set up a VPN connection:

1. Go to **Settings** > **Network & internet**.
2. Touch **Advanced** > **VPN**. If prompted, set a screen lock PIN or password.
3. Touch **+**.
4. Choose the type of VPN and enter settings from the network administrator.
5. To always remain connected to the VPN, check **Always-on VPN**.
6. Touch **Save**.

The network is stored in the VPN list so you can select it when you need to connect.

Connect with Bluetooth™

Pair with Bluetooth device

To connect with a new Bluetooth accessory or other device, you need to pair with it. You only need to do this once for each device.

1. Set the device you want to pair (accessory, computer, other phone, etc.) to Bluetooth discovery mode so that your phone can find it. See the device manufacturer's instructions.
2. On your phone, go to [Settings](#) > **Connected devices**.
3. Touch .

As the phone searches for available devices, you'll see .

4. Touch an available device to connect.
5. Do any of the following:
 - If a pairing code appears on your phone and Bluetooth device, make sure the codes match. (If they don't, touch **Cancel**, verify the name of the device you want to pair with, and try again.)
 - If your device shows a passkey (like 0000 or 1234), enter it on your phone. If you don't see a place to enter it, swipe down from the top of your screen and touch the Bluetooth notification.
 - If your device doesn't show a passkey and you must enter one for the device to pair, see the device manufacturers' instructions.
6. Touch **Pair** on your phone AND touch the pairing prompt on the other device. If you don't confirm on both devices, pairing will fail.
7. [Set sharing options](#) if you'll want to share contacts, phone audio, media audio, or internet access.

Tip: If you use a screen lock, you can define a paired Bluetooth device as a [trusted device](#), keeping your phone unlocked while connected to it. When you disconnect or move out of range, your phone locks again. Go to [Settings](#) > **Security & location** > **Smart Lock** > **Trusted devices**.

Can't pair? Try these [troubleshooting steps](#).

Use paired device

Tip: Bluetooth connections can really drain your battery. Save power by [turning Bluetooth off](#) when you're not connected to a device.

After pairing with a device, you'll need to set sharing options and then you can use Bluetooth to:

- Make or receive [calls](#) with a headset
- Make or receive [calls](#) and play music over your car's audio system
- Transfer [music](#)
- Share [photos](#)
- Share [contacts](#)
- Share [your phone's internet connection](#) with your computer

To set sharing options:

1. Go to [Settings](#) > **Connected devices**.
2. Do one of the following:
 - For a currently connected device, touch the device name.
 - For a paired device you're not connected to, touch **Previously connected devices**, then next to the device name, touch .
3. Turn sharing options on or off.
4. On the paired device or in the device's app, look for Bluetooth settings to review and adjust. For more information, see the paired device manufacturer's instructions.

Reconnect with Bluetooth device

1. Open [quick settings](#) and touch  to turn it on.
2. Turn on the Bluetooth device.

Turn Bluetooth off

Bluetooth uses more of your battery, so turn it off when not in use.

Open [quick settings](#) and touch  to turn it off.

Change phone's name

Your phone name identifies your phone in a Bluetooth network. You can change the name.

1. Go to [Settings](#) > **Connected devices**.
2. Make sure Bluetooth is on.
3. Touch  > **Device name**.

Fix a problem

If you're having problems with a Bluetooth device, try these [troubleshooting steps](#).

Tap & pay with NFC

Only some versions of this phone, sold in certain countries, support this feature.

Use NFC (near-field communication) to pay quickly and [securely](#) at checkout registers by touching your phone to an electronic reader.

Set up Tap & pay

1. Make sure you have:
 - Set up a payment app on your phone. [Install one](#) from Play Store if needed.
 - Turned on [NFC](#).
2. Go to [Settings](#) > [Apps & notifications](#) > [Default apps](#) > [Tap & pay](#).
3. Touch **Payment default**.
4. Touch an app to make it your default payment app.

Note: This feature manages payment apps. Tap & pay doesn't apply to Android Beam and won't include certain apps, such as money transfer apps.

Use Tap & pay

1. Make sure [NFC is on](#) and that the terminal has this symbol:



2. Unlock your phone and touch its back to the terminal.

Your payment app might require you to open the app and enter a PIN before touching your phone to the terminal.

Disable Tap & pay

To disable Tap & pay, turn [off](#) NFC.

When NFC is off, Tap & pay is not included in [Settings](#).

Share or receive with NFC

Only some versions of this phone, sold in certain countries, support this feature.

NFC (near-field communication) makes it easy to [securely](#) share with sources you trust, without having to type a lot of information or struggle with pairing.

Turn NFC on

1. Go to [Settings](#) > **Connected devices** > **Connection preferences**.
2. Turn on **NFC**.
If you don't see this option, then your phone doesn't support NFC.
3. Touch **Android Beam** and make sure it is on.

Share content between devices

Share or beam content from your phone to another device by touching the devices together (usually back to back). Before you begin, make sure both devices are unlocked, support NFC, and have NFC and Android Beam turned on.

1. Open the screen that contains something you want to share, such as a photo, web page, video, map, or contact.
2. Touch the back of your phone to the back of the other device.
When the devices connect, they vibrate and you see **Tap to beam** on your phone.
3. Touch your screen to share the content.

Read NFC tags on posters and signs

Receive web links, e-coupons, brochures, maps, and more from an NFC tag. Look for the NFC logo on NFC-enabled accessories, posters, signs and store displays. Just touch the back of your phone to within 2 cm of the logo to receive its tag information.



Enable NFC icon in status bar

To know whether NFC is on by glancing at your status bar:

1. Go to [Settings](#) > **Connected devices**.
2. Turn **NFC icon** on .

When NFC is on, you'll see  in your [status bar](#).

Turn NFC off

Go to **Settings** > **Connected devices** and turn off NFC.

Cast your screen to TV

Before you begin

- To mirror your entire display on a TV, attach a Chromecast device to your TV or use a TV with [Chromecast built-in](#). Follow product instructions to set it up.
- Make sure your phone and Smart TV or casting device are connected to the same [Wi-Fi](#) network.

Mirror entire display

1. Go to [Settings](#) > **Connected devices** > **Connection preferences** > **Cast**.

Or from [quick settings](#), touch .

2. Touch the name of the device to connect.

If you don't have a **Cast** tile in quick settings, you can [add](#) one.

Cast an app

In a cast-compatible app (like YouTube), touch .



While casting:

- You'll see  in the [status bar](#).
- You can still make and receive calls and use your phone's other features.

If you're using a [VPN](#) and are having trouble casting, turn off the VPN and try again.

Disconnect from TV

Do one of the following:

- On the casting notification, touch  > **Disconnect**.
- On the app screen that is casting, touch  > **Disconnect**.
- From quick settings, touch  > **Disconnect**.

Other ways to share media on TV

- Most smart TVs have mobile apps that allow you to view or play media from your phone.

- If your smart TV supports Wi-Fi Direct, set up a Wi-Fi Direct connection between your phone and TV to view or play media from your phone. See your TV user guide for Wi-Fi Direct setup instructions.

Transfer files between phone and computer (USB)

About USB transfers

You can transfer [music](#), photos, and other files between your phone's storage and computer (in either direction). Use a USB cable that's capable of data transfer and isn't for charging only.

When you connect the phone and computer with the USB cable, the phone's USB connection type is set to charging mode, which charges your battery but prevents your computer from seeing files on your phone. Before transferring files, change the USB connection type to allow transfer of:

- Any type of file
- Only photos and videos

Connect phone to transfer files

1. With the phone and computer turned on, connect the phone and computer with a USB cable.
2. Unlock the phone.
3. Change the USB connection type to allow file transfers:
 1. Swipe down from the top of your home screen and touch the  **Charging this device via USB** notification.
 2. To transfer any type of file, touch **File transfer**.
Or, to transfer only photos and videos, touch **PTP**.

Transfer files

On a Windows computer:

1. Ensure the phone is properly connected to the computer using the steps above.
If you don't unlock the phone and change the USB connection to allow file transfers, you won't see any files on your phone.
2. On your computer, open File Explorer, click the name of your phone, and navigate to its internal storage or SD card.
3. If you selected **PTP** when you connected the phone, in File Explorer choose whether to import pictures and videos automatically or manually.

4. Open a second File Explorer window to see your computer folders.
5. Navigate to the folders or files to transfer, then drag and drop them to and from the open phone storage and computer folders.

On a Mac:

1. Ensure the phone is properly connected to the computer using the steps above.
If you don't unlock the phone and change the USB connection to allow file transfers, you won't see any files on your phone.
2. On your computer, download the Android File Transfer application from www.android.com/filetransfer and follow the onscreen instructions.

Location of files

Files are stored in these folders on your phone:

- **DCIM:** (Digital Camera Images) Photos and videos taken with the Camera app
- **Pictures:** Photos you edited and photos from apps other than Camera
- **Download:** Files [downloaded](#) from the internet
- **Music:** Files for apps that play music
- **Ringtones:** Sound files for ringtones
- **Notifications:** Sound files for [notifications](#)
- **Alarms:** Sound files for [alarms](#)

Fix a problem

If you're having problems, try these [troubleshooting steps](#).

Print from your phone

Set up: Cloud Print

To connect your printer and phone:



1. Be sure your printer is on and added to your Google account. [Learn more](#).
2. Go to **Settings** > **Connected devices** > **Connection preferences** > **Printing**.
3. Touch **Add service** and search for "Cloud Print".
4. Touch the **Cloud Print** app, then touch **Install**.

Set up: Wi-Fi or NFC



To connect your printer and phone:

1. Before you begin:
 - Wi-Fi: Be sure your printer is on and connected to your Wi-Fi network.
 - NFC: Be sure your printer is on and that you've [turned on NFC](#) on your phone.
2. Go to **Settings** > **Connected devices** > **Connection preferences** > **Printing**.
3. Touch **Default Print Service** to automatically find your printer.
Once your printer is found, it is ready to print.

If your printer isn't found in Default Print Service:

1. Touch **Add service**.
2. In Play Store, search for “[printer brand] print service” and install the app for the printer's service plugin.
3. Once installed, return to **Settings** > **Connected devices** > **Connection preferences** > **Printing** and touch the print service plugin name to automatically find your printer.
4. If your printer isn't found automatically, touch  > **Add printer** > .
5. Do one of the following:
 - Wi-Fi: enter the printer's name and IP address (found in your printer settings on connected computer).
 - NFC: touch your phone to the printer's NFC icon.

Print

1. Open the item to print, such as:
 - A photo in Photos
 - An email
 - A document in Drive
 - A web page in Chrome.
2. Touch  or  > **Print**. (In some apps, **Share** > **Print**.)
3. Select printer options if needed.
4. Touch .

About wireless sharing

What you can share

You can share your [photos and videos](#), [contacts](#), [screenshots](#), and [downloaded files](#).

When sharing photos and videos

When deciding how to [share](#) your photos or videos, consider these factors:

- Resolution (high versus low) of the photo or video; high resolution uses more data
- Number of photos to share (one photo or a few or an entire vacation album)
- Whether you want to share on the internet or from device-to-device
- Length of availability for sharing

Ways to share

Method	Description
Message (MMS)	<p>Good for:</p> <ul style="list-style-type: none">• Sharing one photo or a low-resolution video.• Sharing with a friend or group.• Sharing immediately, as an event is happening. <p>Things to consider:</p> <ul style="list-style-type: none">• You and your recipients must have cellular data plans to receive multimedia text messages.• Sending high resolution photos via text message uses more more data.• Photos and video remain available until the recipient deletes the message.• High quality videos are too large and cannot be shared in text messages. <p>Learn how</p>

Email	<p>Good for:</p> <ul style="list-style-type: none">• Sharing one or a few photos.• Sharing with a friend or group.
-------	---

Things to consider:

- Some email providers limit attachment sizes. For large files, upload the file to a cloud storage and email the link instead of the file.
- Email attachments remain available for download until the recipient deletes the email.

[Learn how](#)

Cloud

Good for:

- Sharing high resolution photos, multiple photos, entire albums, and videos.
- Controlling sharing via links.
- Controlling how long you share something; you can easily delete it or turn off sharing privileges.

Things to consider:

- Many cloud services offer free storage with a basic account.
- Cloud storage services are fairly secure, but not completely free from security breaches, so upload wisely.
- Upload over [Wi-Fi](#) to prevent cellular data charges.

[Learn how](#)

Social app

Good for:

- Sharing publicly, with large groups of friends, followers, and subscribers.
- Sharing one photo at a time, or many photos, albums, or videos.
- Controlling how long you share something. You can easily delete it or turn off sharing. Some social networks allow you to post photos and videos for only several seconds, to be viewed but not saved, while some posts remain available indefinitely. Check the social network for specifics.

Things to consider:

- Understand social network privacy and sharing policies before you post.
 - Review updates to social network privacy and sharing policies often.
 - Requires a Wi-Fi or cellular data connection.
-

Bluetooth

Good for:

- Sharing from phone-to-phone or other connected device.
- Fast sharing.

Things to consider:

- Your phone must be [paired and connected](#) with another device.
-

NFC/
Android
beam

Good for:

- Quickly sharing with a nearby phone, tablet, or computer.
- No need for pairing devices; simply [touch](#) them back-to-back.

Things to consider:

- Devices you share with must have NFC.
- Both your phone and the other device must be on and unlocked.

[Learn how](#)

Change app settings

Set or change default apps

If you have multiple apps that do the same thing, you can pick which app to use by default.

Pick when asked

Sometimes, your phone asks which app to use. For example, your phone might ask which app to use to open a PDF file.

To set a default when asked:

1. Touch the app to use.
2. Pick how often you want to use that app for this action: **Always** or **Just once**.

If you select Always, you won't be asked which app to use anymore. To have your phone ask you again, you can clear the default:

1. Go to **Settings** > **Apps & notifications**.
2. Touch **Advanced** > **Default apps** > **Opening links**.
3. Touch the app you selected as default.
4. Touch **Open supported links** and select **Ask every time**.

Pick any time

You can change some default apps (such as [browser](#) or [messaging](#)) at any time:

1. Go to **Settings** > **Apps & notifications**.
2. Touch **Advanced** > **Default apps**.
3. Touch the default to change.
4. Touch the app to use.

Adjust app permissions

The first time you use an [app](#), and sometimes when you [install or update it](#), you are asked to grant the app permission to access certain data and phone features. You can adjust these permissions any time.

To adjust permissions by feature:

1. Go to **Settings** > **Apps & notifications**.
2. Touch **App permissions**.
3. Touch a feature to see which apps have permission to use it.
4. Turn that permission on or off for each app as needed.

You can also [adjust permissions](#) by app, for all features.

Adjust special app access

In **Settings > Apps & notifications > Special app access**, you can adjust these settings.

Usage access: Control which apps have access to data about your app usage (what other apps you're using and how often, your carrier, language settings, and other details).

Unrestricted data: Allow certain apps to use background data even when Data Saver is on. [Learn more](#).

You can also control whether apps have access to features such as [Picture-in-picture](#) , [Battery optimization](#) , and [Do Not Disturb](#) . In general, you shouldn't need to adjust these.

Manage notifications

Stop app from sending notifications

When you receive unwanted notifications from an app, touch & hold the notification, then touch **Stop notifications**.

To review apps and adjust whether they can send notifications:

1. Swipe down to view your notifications.
2. At the bottom of the list, touch **Manage notifications**.
3. Do one of the following:
 - To stop all notifications from an app, turn it off .
 - To stop certain notifications from an app, touch the app name, then turn notifications or off for each category.

Turn notification dots off or on



You can control whether app icons show dots to alert you about unread notifications.



To turn off for all apps:

1. Go to **Settings > Apps & notifications > Notifications**.
2. Turn **Allow notification dots** on or off .

To turn off for one app:

1. Touch & hold the app icon.
2. Touch ⓘ > **Notifications**.
3. Touch **Advanced**.
4. Turn **Allow notification dot** on  or off .

Change notification sound

To change the sound for all app notifications:

1. Go to **Settings** > **Sound** > **Advanced** > **Default notification sound**.
2. Do one of the following:
 - To change it, choose a new sound.
 - To turn notification sounds off, select **None**.

To change the notification sound for a specific app:

1. Touch & hold the app icon.
2. Touch ⓘ > **Notifications**.
3. Touch the category for checkmarked notifications, then touch **Advanced** > **Sound** and select a unique ringtone, or set it to none.

If you don't see **Sound**, touch **Behavior** and select an option that includes sound.

Bypass Do Not Disturb

To let an app's notifications be heard when **Do Not Disturb** is set to Priority only:

1. Touch & hold the app icon.
2. Touch ⓘ > **Notifications**.
3. Touch the category for checkmarked notifications, then touch **Advanced** and turn **Override Do Not Disturb** on .

Control lock screen notifications

If you've [set a pattern, PIN or password](#), you can prevent [lock screen notifications](#) from revealing private information.

To adjust notifications for all apps:

1. Go to **Settings** > **Apps & notifications** > **Notifications**.
2. Touch **On lock screen**.
3. Do one of the following:

- To hide all notifications on your lock screen, touch **Don't show notifications at all**. You can still peek at your notifications--swipe down on the lock screen, then enter your pattern, PIN, or password if required.
- To hide sensitive content in notifications from **all** apps, touch **Hide sensitive content**. For example, you'll get a lock screen notification for an incoming email or chat, but it won't include message details.
- To see all notifications and their content on your lock screen, touch **Show all notification content**.

To hide sensitive content from specific apps:

1. Set lock screen notifications for all apps to **Show all notification content**.
2. Touch & hold the app icon, then touch  > **Notifications**.
3. Touch the category for checkmarked notifications, then touch **Advanced** > **On lock screen** > **Hide sensitive content**.

Turn emergency alerts off/on

Your phone can receive free, life-saving emergency alerts from the Federal Emergency Management Agency (FEMA) to inform you of extreme weather or other threatening emergencies in your area, AMBER Alerts, and Presidential Alerts during national emergencies.

When an emergency alert is sent out,  appears in the status bar. Touch the notification to read the alert.

You can turn most alerts off or on (Presidential Alerts cannot be disabled) and adjust alert notification settings.

Note: Because alerts are intended to save lives, please consider carefully before turning alerts off. For more information, visit <http://www.fema.gov/wireless-emergency-alerts>.

1. Go to **Settings** .
2. Touch **Apps & notifications** > **Advanced** > **Wireless emergency alerts**.
3. Adjust settings as needed.

Stop automatic rotation

Prevent screen from rotating

Open [quick settings](#) and turn Auto-rotate off .

In this mode, you can manually rotate the current app. Touch  by the navigation buttons.



Allow screen to rotate

To allow rotation for all apps, open [quick settings](#) and turn Auto-rotate on .

You can also adjust this in **Settings > Display > Advanced > Auto-rotate screen**

Tip: If your home screen isn't rotating but Auto-rotate is on, then check your home screen settings. Touch & hold a blank spot on your home screen, then touch **Home settings > Allow Home screen rotation**.

Adjust screen colors at night

Set the schedule



1. Go to [Settings](#) > **Display** > **Night Light**.
2. Touch **Schedule**, then:
 - To start and stop at specified times, touch **Turns on at custom time** and enter times.
 - To filter from dusk to dawn, touch **Turns on from sunset to sunrise**.
3. Turn Night Light on .

The first time you turn it on, a  Night Light tile is added to quick settings.

4. Use the slider to adjust the intensity of the amber filter.

Use quick settings

In [quick settings](#), you can:

- Touch  to turn Night Light on at any time.
- Touch & hold  to adjust the intensity of the amber filter.

Adjust screen brightness

Your phone automatically optimizes the brightness of your screen based on current lighting conditions.

Tip: You can also adjust the brightness in [quick settings](#) by sliding .

Adaptive brightness is on by default. To adjust this setting:

1. Go to [Settings](#) > **Display**.
2. Turn **Adaptive brightness** on or off.

Change font and display size

You can make the text or other items on your screen smaller or larger for your comfort and convenience.

1. Go to [Settings](#) > **Display** > **Advanced**.
2. Do any of the following:
 - To adjust the size of text on the screen, touch **Font size**, then drag the slider to the size you want.
 - To adjust the size of icons and other screen elements, touch **Display size**, then drag the slider to the size you want.

If you have visual impairments, turn on [accessibility](#) features.

Change background color

The background of [quick settings](#) and your list of all apps is either light or dark, based on the [wallpaper](#) you selected. To change this:

1. Go to **Settings** > **Display**.
2. Touch **Advanced** > **Device theme**.
3. Choose **Light** or **Dark**.

Change screen timeout

Change when your phone goes to sleep

1. Go to [Settings](#) > **Display** > **Advanced**.

2. Touch **Sleep** and select the time of inactivity before your phone sleeps.

Tip: Set a shorter time to [extend battery life](#).

Stay on until you look away

Use Attentive Display to keep the screen on when you're looking at it and turn it off when you look away:

- Your screen won't dim or sleep when you're looking at it.
- Your screen will sleep sooner when it doesn't see you, saving battery.

In certain lighting conditions, your phone may have difficulty detecting when you've looked away.

To turn on Attentive Display:

1. [Open](#) the **Moto** app.
2. Touch  > **Moto Display**.
3. Touch **Attentive Display** and turn the feature on or off.

About security

Screen lock options

To keep your phone secure, use a [screen lock](#) when it goes to sleep:

- Choose a [pattern, PIN, or password](#) to unlock.
- Add a Smart Lock to unlock automatically when connected to a [trusted device](#), when you're at a [trusted place](#) (like home or work), with [facial recognition](#), or until you [set your phone down](#).
- You can access notifications and quick settings, start a call, and launch the camera from the [lock screen](#).
- You can make emergency calls on a locked phone. A locked phone still rings; you don't need to unlock it to answer.
- If you forgot your pattern, PIN, or password, follow [these steps](#).

You can customize the lock screen by adding [your contact info](#). You can also [control](#) which notifications appear on your lock screen.

NFC transfers

NFC (Near Field Communication) is a short-range wireless technology that lets you quickly [exchange information](#) between your phone and other NFC-enabled smartphones, smart accessories, and smart posters. You can also use NFC to [tap & pay](#) with your phone.

When you use NFC to communicate with other devices, you do so securely:

- NFC only works over a short range (a few centimeters), so it's unlikely that you'll connect by mistake. In order to snag your NFC signal, an eavesdropper would need to be uncomfortably close to you. And you would still have to accept the connection before sending or receiving information.
- Your phone uses the latest security, encryption, and authentication features to protect your personal information.
- You can turn off NFC when you're not using it. But even when NFC is ON, it's automatically disabled when your phone display is locked.

Along with these safeguards, exchange information only with others you know and trust.

Additional security options

For additional security, you can also:

- [Protect](#) your phone in case it's lost or stolen. Use Find My Device.
- Connect to a [virtual private network](#) if you need to access files on a secure network.

- Add a [SIM lock](#) to prevent others from using your cellular plan and accessing account information if your phone is stolen.
- [Prevent viruses](#) and other attacks on your data and privacy with Google Play Protect.



Protect against harmful apps

Scan phone for harmful apps

Play Protect helps keep your phone secure by automatically scanning your phone to check for potentially harmful apps.

If Play Protect finds a potentially harmful app, it stops the app from running and warns you so you can uninstall it.

To see the results or to rescan:

1. [Open](#) the **Play Store** app.
2. Touch  > **My apps & games**.
3. Do any of the following:
 - To see the results of latest scan, on the UPDATES, look at the message next to .
 - To rescan your phone, touch .



If your phone seems slow

If you've scanned your phone to confirm there aren't any potentially harmful apps but your phone seems slow, try these [troubleshooting steps](#).

Set up lost phone features

Find My Device allows you to remotely locate, lock, and erase your phone. To remotely locate your phone, [location services](#) must be on. If not, you can still lock and erase your phone but you can't get its current location.

To confirm that Find My Device is enabled for your phone:

1. Go to [Settings](#) > **Security & location**.
2. Touch **Find My Device** and turn it on .
3. To learn more, touch  > **Help & Feedback**.

To find your lost or stolen phone, on a computer go to android.com/find.

Set screen lock

Screen lock options

When you set a screen lock, each time you turn on your phone or [wake the screen](#), you'll be asked to unlock your phone.

No lock:

- **None:** This gives no protection, but you can quickly access your home screen.
- **Swipe:** Swipe  up. This prevents accidental dialing but doesn't secure the phone.

Lock:

- **Pattern:** Draw a pattern on a grid.
- **PIN:** Enter a four to sixteen digit numeric code. Longer PINs are more secure.
- **Password:** Enter four to sixteen letters, digits, or symbols for the password. A long, strong password is the most secure option.

When you're using any of the 3 locks, you can also unlock with your [fingerprint sensor](#) and set your phone to [automatically unlock](#) in certain conditions.

Set or change screen lock

1. Go to [Settings](#) > **Security & location**.
2. Touch **Screen lock** and select the type of lock you want.

Some options aren't available if you added a [VPN](#) or a work (corporate) email account to your phone.



Hide your password or pattern

You can hide your password or pattern to prevent others from viewing it when you unlock your screen.

For passwords:

1. Go to [Settings](#) > **Security & location** > **Advanced**.
2. Turn **Show passwords** off .

For patterns:

1. Go to [Settings](#) > **Security & location**.
2. Touch .
3. Turn **Make pattern visible** off .

Quickly tighten lock screen security

Unlocking with the [fingerprint sensor](#) and setting up [automatic unlocking](#) make it easier to keep your phone secure and minimize when you need to enter your PIN, pattern, or password. But sometimes you need to trade convenience for more security. You can temporarily tighten locks and prevent lock screen notifications.

To set it up:

1. Go to [Settings](#) > [Security & location](#) > [Lock screen preferences](#).
2. Turn **Show lockdown option** on .

To use it:

1. Touch & hold the Power button.
2. Touch **Lockdown**.

Your fingerprint sensor and automatic unlock settings are disabled and notifications won't be displayed on your lock screen.

3. To exit Lockdown, unlock your phone with your PIN, pattern, or password.

Unlock your screen automatically

If you're using a PIN, password, or pattern, you can:

- Stay unlocked when [connected to a device](#), like your car audio system.
- Stay unlocked at a [specific location](#).
- Stay unlocked when [holding or carrying](#) your phone.
- Unlock with [your face](#).
- Unlock with [your voice](#).

Tips:

- You can swipe up from anywhere on the screen when unlocking. You don't need to touch the  icon.
- Some of these options aren't available if you added a [VPN](#) or a work (corporate) email account to your phone.

Fix a problem

If you forgot your PIN, pattern, or password, try these [troubleshooting steps](#).

Unlock with trusted devices

Set up trusted devices

You can keep your phone unlocked when it is connected to a trusted device, like your Bluetooth watch or car.

1. Make sure you have:
 - Set a [screen lock](#) on the phone.
 - Turned on [Bluetooth](#) on the phone.
 - Paired your phone with the device.
2. Go to [Settings](#) .
3. Touch **Security & location > Smart Lock**.

If you don't see Smart Lock, try the following:

- Update Google Play services. In the Google Search widget on your home screen, search for “Google Play services”, then touch the app to open it in Google Play.
 - Go to **Settings > Security & location > Advanced > Trust agents** and enable **Smart Lock**.
4. Unlock your phone, then touch **Trusted devices > ADD TRUSTED DEVICE**.
 5. Touch a device to select it from the list of connected devices.

Tip: If your device isn't in the list, make sure you are [paired](#) with it.

When the phone is connected to the device, the phone automatically unlocks.

Remove trusted devices

1. Go to [Settings](#) .
2. Touch **Security & location > Smart Lock**.
3. Unlock your phone, then touch **Trusted devices**.
4. Touch the device name, then touch **OK** to confirm.

Manually lock phone

If you need to make sure the phone stays locked even when you're connected to a trusted device, you can manually lock the phone.

On the lock screen, touch . The phone stays locked until the next time you manually unlock it.

Unlock with your face

Set up face matching

1. Make sure you have set a [screen lock](#) on the phone.
2. Go to [Settings](#) .
3. Touch **Security & location > Face Unlock**.

If the option is grayed out, go to **Settings > Security & location > Device admin apps** and disable the device administrator.



4. Follow the onscreen instructions. Be sure to frame your entire face with the outline.

Whenever you turn on or wake the phone, it will search for your face and unlock when it recognizes you. Keep in mind that someone who looks similar to you could unlock the phone.

Face matching data is stored securely on the phone.

Unlock your phone

1. Show your face to the lock screen.

 appears when the phone is looking for your face. When it recognizes you, it unlocks and displays .

2. Swipe  up.

If it doesn't recognize you, it stays locked and displays one of these icons.

Icon How to unlock



Use your password, PIN, or pattern



Use the fingerprint sensor

Turn off face matching

1. Go to [Settings](#) .
2. Touch **Security & location > Face Unlock**.
3. Unlock your phone, then touch **Disable face unlock**.

Fix a problem

If you're having trouble getting the phone to recognize your face:

1. Go to [Settings](#) .
2. Touch **Security & location** > **Face Unlock**.
3. Unlock your phone, then touch **Redo face scan**.
4. Follow the onscreen instructions.

Unlock at trusted places

Set up trusted places

To avoid repeatedly unlocking your phone when you are at familiar and trusted locations (like home or work), use a Smart Lock. You can still manually lock the phone at trusted places when needed.

1. Make sure you have:
 - Set a [screen lock](#) on the phone.
 - Turned on [location](#) services.
 - Entered your Home and Work locations in Maps ( > **Edit home or work**) if desired.
2. Go to [Settings](#) .
3. Touch **Security & location** > **Smart Lock**.

If you don't see Smart Lock, try the following:

- Update Google Play services. In the Google Search widget on your home screen, search for "Google Play services", then touch the app to open it.
 - Go to **Settings** > **Security & location** > **Advanced** > **Trust agents** and enable **Smart Lock**.
4. Unlock your phone, then touch **Trusted places**.
 5. Set up your places:
 - If you added Home or Work locations in Maps, touch the location name and turn it on if desired.
 - To add a location, touch **Add trusted place**. Verify your current location to add it, or touch , type the address to add, and touch **Select this location**.

Manually lock phone

To lock your phone when you're in a trusted place, on the lock screen, touch . The phone stays locked until the next time you manually unlock it.

Remove trusted places

1. Go to [Settings](#) .
2. Touch **Security & location** > **Smart Lock**.
3. Unlock your phone, then touch **Trusted places**.
4. Remove the location from your trusted places:
 - For your Home or Work locations in Maps, touch the location name to toggle it off. To remove the address entirely, you must remove it in Maps.
 - For custom places you added, touch the location name, then touch .

Keep phone unlocked while it's on you

You can keep your phone unlocked while you're holding it in your hand or carrying it in your pocket or handbag. Just unlock it once, and it stays unlocked until you set it down (or manually lock it).

1. Make sure you have set a [screen lock](#).
2. Go to [Settings](#) .
3. Touch **Security & location** > **Smart Lock**.
If you don't see Smart Lock, try the following:
 - Update Google Play services. In the Google Search widget on your home screen, search for "Google Play services", then touch the app to open it.
 - Go to **Settings** > **Security & location** > **Advanced** > **Trust agents** and enable **Smart Lock**.
4. Unlock your phone, then touch **On-body detection**.
5. Turn it on.



Unlock with voice commands

Set up voice authentication

If you use “OK, Google” for [voice commands](#), you can use Smart Lock to unlock your phone when it recognizes your voice.

1. Make sure you have set a [screen lock](#).
2. Go to [Settings](#) .
3. Touch **Security & location** > **Smart Lock**.

If you don't see Smart Lock, try the following:

- Update Google Play services. In the Google Search widget on your home screen, search for “Google Play services”, then touch the app to open it.
 - Go to **Settings** > **Security & location** > **Advanced** > **Trust agents** and enable **Smart Lock**.
4. Unlock your phone, then touch **Voice Match**.
 5. Turn **Access with Voice Match** on . If you haven't already set up the “OK, Google” launch phrase, follow the onscreen instructions to record your voice.
 6. Be sure **Unlock with Voice Match** is on .

Unlock your phone

1. At the [lock screen](#), say “OK, Google”.
Your phone unlocks and is ready for commands.
2. [Speak a command](#) to perform a task.

If the phone does not recognize your voice, then unlock it with your password, PIN, or pattern.

Turn off voice authentication

1. Go to [Settings](#) .
2. Touch **Security & location** > **Smart Lock**.
3. Unlock your phone, then touch **Voice Match**.
4. Turn **Unlock with Voice Match** off .

Use fingerprint security

Set up fingerprint security

Use the [fingerprint sensor](#) to unlock your phone, make fast and secure online and in-store purchases, and sign into bank and finance apps.

1. Go to [Settings](#) > **Security & location**.
2. Touch **Fingerprint**.
3. Follow the onscreen instructions to scan your fingerprint using [the sensor](#) on the back of your phone.

Fingerprints are [stored securely](#) on the phone.

Add more fingerprints

Keep in mind that:

- If multiple users [share the phone](#), users should add their fingerprints from within their [user profile](#), instead of adding multiple fingerprints to your owner profile.
- Anyone whose fingerprints are added to a user profile can unlock the phone and authorize purchases with the associated [Google account](#) or apps.

Add a fingerprint for each finger you want to use with the sensor:

1. Go to [Settings](#) > **Security & location**.
2. Touch **Fingerprint** and enter your pattern, PIN, or password to verify your identity.
3. Touch **Add fingerprint**.
4. Use the fingerprint sensor to scan another fingerprint.
5. Rename each fingerprint. Touch the current name, type a name, and touch **OK**.

Remove a fingerprint

1. Go to [Settings](#) > **Security & location**.
2. Touch **Fingerprint** and enter your pattern, PIN, or password to verify your identity.
3. Touch  next to the fingerprint.

Use fingerprint to unlock phone

To wake and unlock your screen, or any time you see  on the screen, touch the sensor to verify your identity.

To get more screen space by removing the  navigation icons and navigating with the fingerprint sensor, turn on [One Button Nav](#) in the Moto app.

Tip: You can temporarily turn off fingerprint unlocking and lock screen notifications with [Lockdown mode](#).

Use fingerprint to sign in to apps

To use the fingerprint sensor with third-party apps:

- Be sure the app supports fingerprint recognition.
- [Install](#) the app and open its settings to adjust options, like enabling fingerprint unlock.
- Consult the app's help info for more instructions.

Why am I still asked for PIN/pattern?

For maximum security, you still need to enter your pattern, PIN, or password:

- Every time you power up your phone
- When more than 72 hours have passed since you last unlocked the phone
- When you go to **Settings > Security & location > Fingerprint**
- When the sensor can't read the fingerprint

Fix a problem

Problem: Sometimes the sensor can't read my fingerprints.

Each finger has a unique print. If you've added only one fingerprint, add more for other fingers you want to use with the sensor.

The sensor may have trouble reading fingerprints if your finger is:

- Wet
- Oily
- Dirty
- Injured (Add fingerprints for your other fingers and use them until healed.)

If a registered fingerprint isn't working as expected, [remove](#) and re-add the fingerprint.

Problem: Fingerprint option disappeared from Security & location menu.

After each troubleshooting step, check to see if your issue is fixed.

1. Turn your phone off and then on again.

2. Check if a [software update](#) is available for your phone.
3. Check for app updates.
[Open](#) the **Play Store** app and touch  > **My apps & games**.
4. Use [safe mode](#) to see if apps you installed are causing the issue and uninstall as needed.
If the sensor works correctly in safe mode, a 3rd party app is probably causing the issue. These apps can cause issues: lock screen apps, app locks that use the fingerprint sensor, RAM boosters, and RAM cleaners.
5. [Reset](#) the phone.

Use location services

About location information

You can let your phone use GPS, Wi-Fi networks, and mobile networks to estimate your location. Apps that have your permission can use this information to deliver location-based services, such as the ability to check in, view commute traffic, find nearby restaurants, or tag your photos with the location where you took them.

Turn location on or off

To control what location information your phone can use:

1. Go to [Settings](#) > **Security & location** > **Location**.
2. Turn it on or off to give or remove permission to use your location information. When it's off, your phone can't find your precise location or share it with any apps. However, turning this off disables many useful features and apps.

Tip: To add a Location tile to quick settings, [open](#) quick settings. Touch . Then drag the Location tile where you want it.

Review apps using your location

To see which apps have recently accessed your location:

1. Go to [Settings](#) > **Security & location** > **Location**.
2. Under Recent location requests, review the list of apps that have recently received your location.
3. To prevent an app from accessing your location:
 1. Touch **App-level permissions**.

2. Turn **Location** off .

Lock SIM card

Set up SIM lock

Your SIM card came with a default PIN from your carrier. You can use it to set up an optional SIM card lock, which prevents others from using your cellular plan and accessing account information if your phone is stolen.

If you add a SIM lock, you will be prompted to enter the PIN each time you swap SIM cards or restart the phone.

1. Be sure you have the PIN your carrier provided with the SIM card. If you don't have it, contact your carrier.
2. Go to **Settings** > **Security & location** > **Advanced** > **SIM card lock**.
3. If your phone has dual SIM cards, touch the SIM to lock.
4. Turn **Lock SIM card** on .
5. Enter your carrier-provided PIN and follow the onscreen instructions.

Unlock SIM card

When prompted, enter the PIN used to set up the SIM lock.

Caution: If you enter an incorrect PIN multiple times, the SIM will be disabled.

If you accidentally disabled SIM

If you enter an incorrect PIN multiple times, the SIM will be disabled.

Contact your carrier for a PIN unlock key (PUK) to re-enable the SIM.

Add or remove accounts

About accounts

When you set up your phone, you were prompted to add a Google account. If you skipped this, be sure to set one up now so you can download apps from Play Store, get a customized information feed, and take full advantage of the Calendar, Gmail, and other apps included with [your account](#).

You can also add other web accounts.

For each account, you can control which of its features and apps [sync](#) with your phone.

Add Google account

To add a [Google account](#):

1. Go to [Settings](#) .
2. Touch **Accounts > Add account**.
3. Touch **Google** and follow the onscreen instructions to add an existing account or to create a new one.
4. Once the account is added, [Calendar](#) , [Contacts](#) , and other account features and apps are updated with information from that account. You can review and change what [syncs](#) with your phone for that account.

Tip: Keep your apps [up-to-date](#). To see if newer versions of the apps associated with your Google account are available, open the Play Store app and touch  > **My apps & games**.

Add non-Google account

You can add corporate email accounts, personal email accounts, or other accounts. Many social networking accounts are automatically set up when you install the app.

1. Go to [Settings](#) .
2. Touch **Accounts > Add account**.
3. Do one of the following:
 - Touch the type of account to add and follow the onscreen instructions. [Learn more](#) about setting up email accounts.
 - If you don't see the type of account you want to add, [install](#) the related app from Play Store, then sign into your account through the app.

4. Once the account is added, account-related features and apps are updated with information from that account. To review and change what **syncs** with your phone, touch the account type, then account name.

Remove account

If you remove an account, information you **synced** will be removed from your phone, but it is not deleted from your account.

To remove other accounts:

1. Go to **Settings** > **Accounts**.
2. Touch the account name.
3. Touch **Remove account**.

Tip: If you have trouble removing a corporate account, go to **Settings** > **Security & location** > **Device admin apps** and remove the checkmark for the account, then try to remove it again.



Sync accounts and apps

About syncing

You can manage how apps connected to your **accounts** are synced on your phone. Keep them all automatically up to date or just sync specific apps. You can also manually sync your data only when you need to.

The more you sync, the more **battery** your phone uses, so if you need to conserve, turn off sync for account features or apps you find less important. If you want to **reduce usage** of mobile data, turn off auto-sync entirely and instead sync accounts manually, or wait to sync manually over Wi-Fi.



Adjust auto-sync options for an account

1. Go to **Settings** > **Accounts**.
2. Touch the account name.
 -  by the account name means that some or all of the account's information is configured to auto-sync.
 -  by the account name means that the account will not auto-sync.
3. Touch **Account sync**.

4. Review the information and turn on/off types of account information to sync. For example, set your [Google account](#) to sync your Calendar and Gmail but not to sync for Drive.

When you turn off sync, the information is not removed from your phone; it just is no longer kept in sync with the version on the web.

Turn auto-sync off/on for all accounts

1. Go to [Settings](#) > **Accounts**.
2. Turn **Automatically sync data** on  or off .

To collect messages, email, calendar, or other app updates, you must sync the accounts manually.

Sync manually

1. Go to [Settings](#) > **Accounts**.
2. Touch the account name.
3. Touch **Account sync** >  > **Sync now**.

Fix a problem



If you're having problems, try these [troubleshooting steps](#).

Manage your personal information

How Google uses and protects your information



Google collects information from you to provide personalized services and tailored content, as outlined in the [Google Privacy Policy](#).

Delete items from history

1. [Open](#) the **Google** app.
2. Touch  > **Settings**.
3. Touch **Accounts & privacy**.
4. Do one of the following:
 - To view a list of all of your information, touch **My Activity**. Then touch  > **Delete** next to items to delete.

- To view and delete your history for a specific activity (search, YouTube, recordings of your voice commands, location), touch **Google activity controls**. For each activity, touch **Manage Activity**, and delete as needed.

Turn information collection off or on

1. [Open](#) the **Google** app.
2. Touch  > **Settings**.
3. Touch **Accounts & privacy** > **Google activity controls**.
4. Next to the activity, touch  to pause or  to restart the collection of that information.

Set up emergency information

You can set up emergency information, such as your emergency contact, and medical information, such as your blood type.

First responders or other people can view this information from your lock screen.

To set up your emergency information:

1. Go to **Settings** > **System** > **About phone**.
2. Touch **Emergency information**.
3. Set up your information.

To view this information, a first responder or other person would:

1. Swipe up on the lock screen.
2. Below the keypad, touch **Emergency**.
3. Touch **Emergency information** twice.

Record your IMEI number

The IMEI (International Mobile Equipment Identity) number is the unique code that identifies your phone. You'll need it if you contact support regarding a warranty, and it's important to have if your phone is stolen.

Service providers can use the IMEI to block a stolen phone from cellular networks, and many police departments keep a record of stolen phones using this number.

You may never need your IMEI number, but it's a good idea to record it, just in case.

To find the IMEI number:

1. Go to **Settings** > **System** > **About phone**.
2. See **IMEI** for your number.
3. Record and save the number where you can easily access it.

You can also find your IMEI number by dialing ***#06#** in the Phone app. On some phones, the MEID HEX number is your IMEI number.

Find legal and product information

To view the electronic regulatory label for your phone, go to **Settings** > **System** > **Legal information** > **Regulatory information**.

For safety, environmental, warranty, and other legal information, go to **Settings** > **System** > **Legal information**.

Printed legal information may also be provided with your phone.

To find your phone's model number, go to **Settings** > **System** > **About phone** > **Hardware information** > **SKU**.

Use multiple languages

Change display language

You selected the language for your phone during set up. To change it:

1. Go to **Settings** > **System** > **Languages & input** > **Languages**.
2. Touch & hold the language you want and drag it to the first position in the list.
3. If you don't see the language you want, touch **+** to add it, then drag it to the first position.

All languages added to the list will appear on [the keyboard's spacebar](#).

To remove a language, go to **Settings** > **System** > **Languages & input** > **Languages**, then touch **⋮** > **Remove**.

Add language to keyboard

If you want a keyboard for a language that isn't a display language:

1. Go to **Settings** > **System** > **Languages & input** > **Virtual keyboard**.
2. Touch **Gboard** > **Languages**.
3. Touch **ADD KEYBOARD**.
4. Select the language.
5. Touch **Done**.

Then, [switch between languages](#) on the keyboard by touching .

Share your phone

Ways to share your phone

- **Add users.** If you share your phone with family, friends, or within a business, you can set up separate user spaces for each of them.
- **Lend to people as guest.** This is a more temporary space that you or the guest can delete when finished.
- **Pin the screen.** This lets you keep one specific app or screen in view. For example, you can pin a game and your child cannot navigate anywhere else on your phone.

About owners, users, and guests

The owner can:

- Determine whether users and guests can make phone calls and send text messages, which also allows them to see the phone's call history and text history.
- Reset, update, and uninstall any apps.
- Delete user and guests, removing any associated accounts and data from the phone.

Users and guests can:

- Set up [Google accounts](#) and other types of accounts.
- Set up a [screen lock](#).
- Customize the home screen and settings for their spaces.
- Add and delete apps for their spaces, and update any apps they use, regardless of who installed them.

Important: To prevent others from switching to your owner profile and accessing your information, set a [screen lock](#) before you share your phone with users or guests.

When sharing your phone with users and guests, some apps are only available to the owner, not to other users and guests.

Switch users

Only the owner can switch to the guest profile for loaning the phone and can switch between user profiles.

To switch user profiles or see which is currently active, open [quick settings](#). At the top of the screen, you'll see one of these icons after you've [set up a user](#) or [added a guest](#).

Icon Meaning



Owner (If you set up your profile in Contacts and included a picture, you'll see it and your name instead.)



Guest



Added user

Add, modify, remove users

Add a user

You must be the device owner to add users.



1. To prevent others from switching to your owner profile and accessing your information, set a [screen lock](#) before you share your phone.
2. Go to **Settings** > **System** > **Advanced** > **Multiple users**.

Tip: To add users from quick settings on your lock screen without unlocking the phone, go to **Settings** > **System** > **Advanced** > **Multiple users** and turn **Add users from lock screen** on .

3. Touch **Add user** > **OK**.
4. Give the phone to the new user to set up the profile.



Restrict calls and messages

From your [owner](#) profile, you control whether users can call and send texts with your phone:

1. Go to **Settings** > **System** > **Advanced** > **Multiple users**.
Or from quick settings, touch  > **More settings**.
2. Next to the user name, touch .
3. To allow the user to make calls and send messages, switch on **Turn on phone calls & SMS**.

Remove a user

You can remove yourself as a user. You must be the device owner to remove other users.

1. Go to **Settings** > **System** > **Advanced** > **Multiple users**.
Or from quick settings, touch  > **More settings**.
2. Do one of the following:
 - To remove yourself as a user, touch .
 - To remove other users if you are the device owner, next to the user name, touch .
3. Touch **Remove user**.

Add or delete guest

Lend to guest

Create a temporary profile for **sharing** your phone with someone.

1. Go to **Settings** > **System** > **Advanced** > **Multiple users**.
2. If you want to prevent the guest from making calls, touch  and switch **Turn on phone calls** off.
3. Touch **Guest**.
4. If you've lent your phone to a guest previously, touch **Start over** to clear the last guest settings, or touch **Yes, continue** to keep last guest settings.

End guest session

1. Go to **Settings** > **System** > **Advanced** > **Multiple users**. Or from quick settings, touch .
2. Touch **Remove guest** > **Remove**.

All data from and apps installed during this session are deleted.

Phone is slow or unstable

Pinpoint the problem

What type of issue are you seeing?

- If your phone is slow when running all apps and tasks, it's probably a problem with your phone, not an app on your phone. Try the troubleshooting steps below.
- If the problem is specific to one app, try these [app-specific troubleshooting steps](#).
- If you're using Wi-Fi and your phone is slow when you view websites or watch videos online, it could be a problem with your connection. Try using a different Wi-Fi network or contact your Internet Service Provider.

Troubleshoot phone performance

After each step, check to see if the issue is fixed:

1. Turn your phone off and then on again.
 - Press and hold the Power button, then touch **Power off**.
 - If your phone is frozen, reboot it by pressing and holding the Power button for 7-10 seconds.
2. Check for system updates.

Go to [Settings](#) > **System** > **Advanced** > **System updates**.
3. Check for app updates.

[Open](#) the Play Store app and touch  > **My apps & games**.
4. Check [available storage](#) and clear space if needed.

Phone feels warm or hot

Overview

It's normal for your phone to feel warm, or even hot, depending on how you're using it.

If your phone ever becomes too hot, it will ask you to turn it off so it can cool down. Some phones will stay on but limit the phone's capabilities until it cools down.

If your phone is too hot to touch, use a different phone, tablet, or computer to contact [Motorola support](#).

Reasons your phone may get warm

Doing one or more of the following activities may cause your phone to get warm:

- Playing videos, games, or other media apps
- Using GPS navigation
- Tethering your phone or using it as a Wi-Fi hotspot
- Using phone while it's [charging](#)
- Downloading or uploading a lot of data

Ways to keep your phone from heating up

- Pause resource-intensive features or apps until your phone cools down.
- Always use the charger that came with your phone.
- Keep your phone away from direct heat or excessive sunlight.
- Don't keep your phone in enclosed or poorly ventilated areas where heat can easily build up.
- Reduce your phone's [display brightness](#).

If you're not using or charging it

Sometimes a process can get stuck in the background. If your phone is hot but you're not using or charging it, turn your phone off and on again. This will stop the previously stuck process and resolve the issue.

Phone won't turn on

If your phone isn't starting, won't turn on, has a black or blank screen, or turns on but immediately turns off, try these steps to fix the issue.

1. Hold down your phone's Power button for 5-7 seconds, or up to 30 seconds.
This should restart (or "reboot") your phone.
2. [Charge](#) the phone.

If your phone has a [sign-of-life indicator](#), look for a white light near the top front of the phone. This indicates that the phone is charging but battery is too low to power the screen.

Tips:

- Remove any case, as this may impede the charger/port connection.
- Use the charger that came with the phone.
- Check that the charging cable fits snugly into the phone and that the cable fits snugly into the outlet.
- If you're having trouble charging, try these [troubleshooting steps](#).

3. If you don't see a battery icon after you plug your phone in to charge, the issue could be with your screen. Check if your phone rings by calling it from another phone. If it rings, the issue is with your screen and you can try these [troubleshooting steps](#).
4. Perform an external reset of your phone. [Learn how](#).

Phone restarts or crashes

If your phone randomly reboots, restarts, or shuts down without restarting, try the following.

Restart your phone

1. Hold down the Power button for about 30 seconds.
2. If this doesn't work, connect your phone to charge for at least 5 minutes. Then, while connected to the charger, restart again by holding down the Power button for 30 seconds.

Troubleshoot your phone

1. Check if a [software update](#) is available for your phone.
2. Check [available storage](#) and [clear space](#) if needed.

You may see issues if your phone's internal storage is almost full. To free up space, remove unnecessary files and clear cached data.

Troubleshoot your apps

1. Check for [app updates](#).
2. Use [safe mode](#) to see if apps you installed are causing the issue and uninstall as needed.

If your problem doesn't go away in safe mode, restart your phone and continue to the next section.

Reset to factory settings

To remove any processes on your phone that may be causing the issue, you can [reset your phone](#) to factory settings.

A factory data reset will remove all data from your phone.

Screen is frozen or won't respond

If your phone freezes, stops responding, or is stuck on a blank or white screen, try the following.

Restart your phone

1. Hold down the Power button for about 30 seconds.
2. If this doesn't work, charge your phone for at least 5 minutes. Then, while connected to the charger, restart again by holding down the Power button for 30 seconds.

If your phone freezes again

If your phone freezes more than once, check for a larger issue.

Restart your phone to unfreeze it, and then try these troubleshooting steps:

1. Check if a [software update](#) is available for your phone.
2. Check [available storage](#) and [clear space](#) if needed.

You may see issues if your phone's internal storage is almost full. To free up space, remove unnecessary files and clear cached data.

3. Check for [app updates](#).

If you can't unfreeze the phone

To remove any processes that may be causing the issue, [reset your phone](#) to factory settings.

A factory data reset will remove all data from your phone.



Problems making/receiving calls

After each troubleshooting step, check to see if your issue is fixed.

icon is missing

If  disappeared from your home screen, you just need to [add a shortcut](#) for the Phone app.



SIM card not recognized

If you see  or  in the [status bar](#) or a message that the SIM is not recognized:

1. Turn your phone off and then on again.



Press and hold the Power button, then touch **Power off**. Then turn it on to establish a new connection with the network.

2. Do one of the following:

- If your phone allows one SIM card, turn your phone off, then [remove](#) and reinsert the SIM.
- If your phone allows dual SIMs, disable the SIM, then enable it again. Go to [Settings](#) > **Network & internet** > **SIM cards**. Turn the SIM off . Then turn it on .

3. If your phone has dual SIMs, turn your phone off, then [remove](#) the SIM that is not recognized and try it in the other SIM slot.
4. Contact your carrier to make sure your account is set up properly.
5. Ask your carrier to replace the SIM card.
6. Perform an external phone [reset](#).

No signal

1. If you usually have a signal  but the [status bar](#) shows  in your current location, move to another area where you can receive a signal, like outdoors. If you're uncertain whether your carrier provides service in that location, check the coverage map on your carrier's website.
2. If [airplane mode](#) is on, turn it off.
3. Turn your phone off and then on again.
4. Check for [app updates](#).
5. Check if a [software update](#) is available for your phone.
6. Check that the **Preferred network type** is set to **Global**. ([Settings](#) > **Network & internet** > **Mobile network** > **Preferred network type**.) If you're experiencing service issues when it is set on **Global**, try a different setting.



7. Manually set the network operator:
 1. Go to **Settings** > **Network & internet** > **Mobile network**.
 2. Touch **Network operators** > **Search networks**.
 3. Wait 30 seconds for the search results.
 4. Choose your network operator (carrier).
 5. Wait 30 seconds for the network to refresh the signal.
8. **Remove** your SIM card and reinsert.
9. Use **safe mode** to see if apps you installed are causing the issue and uninstall as needed.
10. **Reset** the phone.

Have signal, but can't make calls

1. Turn your phone off and then on again.

Press and hold the Power button, then touch **Power off**. Then turn it on to establish a new connection with the network.
2. Clear the **cache** for the Phone app.
3. Use **safe mode** to see if apps you installed are causing the issue and uninstall as needed.
4. Check if a **software update** is available for your phone.
5. **Reset** the phone.

Phone doesn't ring or ring loud enough

1. Check your **volume** setting.
2. Look for  in your **status bar**. If you see it:
 - Open **quick settings** and touch  to turn Do Not Disturb off. Your phone will ring for incoming calls.
 - Make sure your phone is set to **screen calls** at the appropriate times.
3. Check that your **ringtone** is not set to **None**.
4. Is your phone connected with a **Bluetooth device**? If so, all audio is routed to the Bluetooth device.
5. If you're using a ringtone that you installed, try using a ringtone that came with the phone.
6. Use **safe mode** to see if apps you installed are causing the issue and uninstall as needed. Begin with application types like launchers, task killers, or anti-virus apps.

Can't answer ringing phone

Check that Phone app notifications haven't been disabled.

Touch & hold , then touch  > **Notifications** and make sure they are on .

Consistent busy signal

Outbound calls

1. If you hear a fast busy signal when you call a number, all cellular circuits may be in use, preventing the call from going through. Try calling again later.
2. If you hear a fast busy signal every time you call the same number, your number may be blocked by an app. Try calling from a different number.

Incoming calls

If you have a signal and can make calls, but callers tell you they consistently get a busy signal when calling you, check that you haven't [blocked their numbers](#).

Problems during calls

After each troubleshooting step, check to see if your issue is fixed.

Screen goes black

1. If you are using a case, cover or screen protector, remove it and see if it was causing the issue.
2. Check your [proximity sensor](#).
Dial a call and set the phone on a table (don't use speaker mode), then hold your hand over the proximity sensor to see if you can turn the screen off and on.
3. Use [safe mode](#) to see if apps you installed are causing the issue and uninstall as needed.

Calls are dropping



1. Check your signal strength:
 - Weak signal from your cellular provider is a common cause of dropped calls. In the [status bar](#), see how many bars your network connection has. If you see only one or two bars, change locations to improve your signal strength, particularly if you are indoors.

2. Turn your phone off and then on again.

Press and hold the Power button, then touch **Power off**. Then turn it on to establish a new connection with the network.

3. During a call, check that the [proximity sensor](#) works by covering it to confirm that it turns off your screen, preventing accidental touches during calls. You can also download an app to automatically lock your screen during calls; search for “call screen lock” on Play Store.
4. Use [safe mode](#) to see if apps you installed are causing the issue and uninstall as needed.
5. Check if a [software update](#) is available for your phone.
6. [Reset](#) the phone.



People can't hear me on calls

1. Check that nothing is covering the [microphone](#):
 - If you are using a case, cover or screen protector, remove it and see if it was causing the issue.
 - Check that the protective film that ships with the phone has been removed.
2. Check to see if your phone is using Voice privacy. (This feature is not available on all models.) Turn it off to see if sound quality improves:
 1. Touch .
 2. Touch  > **Settings** > **Calls**.
 3. Turn off **Voice privacy**.
3. If the issue occurs while using the speakerphone or a Bluetooth headset, check your signal strength.

In the [status bar](#), see how many bars your network connection has. If you see only one or two bars, change locations to improve your signal strength, particularly if you are indoors.

4. Turn your phone off and then on again.

Press and hold the Power button, then touch **Power off**. Then turn it on to establish a new connection with the network.

5. Check if a [software update](#) is available for your phone.
6. Turn off Voice Match.
 1. Open the Google app.
 2. Touch  > **Settings** > **Voice** > **Voice Match**.
 3. Turn **Access with Voice Match** off .

Saying “OK, Google” won't work from all screens, but you can touch the search widget first, then say “OK, Google”.

7. Use [safe mode](#) to see if apps you installed are causing the issue and uninstall as needed.
8. [Reset](#) the phone.

Poor sound quality on calls

Start by checking your [volume](#) setting. You can only adjust the call volume with the Volume buttons while you're on a call.

Wired headset

1. Make sure the headset is inserted completely into the [headset jack](#).
2. If you are using a case or cover, remove it and re-insert the headset to see if it was interfering.
3. Try a different headset to determine if the issue is with the original headset.

Earpiece

1. Check that nothing is covering the [microphone](#):
 - If you are using a case, cover or screen protector, remove it and see if it was causing the issue.
 - Check that the protective film that ships with the phone has been removed.
2. While in a call, try using the speakerphone or a wired headset to see if the sound quality improves. If it doesn't, the issue is probably network signal strength instead of hardware.
3. Turn your phone off and then on again.

Press and hold the Power button, then touch **Power off**. Then turn it on to establish a new connection with the network.

4. Use [safe mode](#) to see if apps you installed are causing the issue and uninstall as needed.
5. Check if a [software update](#) is available for your phone.
6. [Reset](#) the phone.

Bluetooth device

Check battery level of Bluetooth device and phone, and charge if necessary. Bluetooth devices may disconnect or create noise when the phone or Bluetooth battery are low.

Can't make/receive calls

Try these [troubleshooting steps](#).

Charging problems

If the phone charges slowly or will not charge, try these troubleshooting steps. After each step, check to see if your issue is fixed.

1. Make sure the [USB plug](#) fits securely into the phone.
2. If the battery has been completely depleted, connect the charger and wait about 10 minutes until it has enough voltage to charge, then press the Power button.
3. If you're charging by connecting to a wall outlet:
 - Use the charger that came with the phone.
 - Inspect the charger for damage to the wire or plug. If you see damage, try charging by connecting to your computer with a USB cable.
 - If the outlet you're using is controlled with a switch, check that it is turned on.
 - Check the outlet for damage or loose parts. If you see damage, try another outlet.
4. If you're charging by connecting to your computer, check the USB connection:
 1. Swipe the [status bar](#) down.
 2. On the USB notification, touch , then touch the notification.
 3. Touch **No data transfer**.
5. Reboot the phone by holding the Power button for 7-10 seconds.
6. [Reset](#) the phone.

Battery drains too fast

Battery life varies

The way you use your phone can really affect how long you can go before recharging your battery. Navigating, playing games, browsing the web, making calls and texting all require energy. So, your battery life may vary day to day, depending on what you're doing.

If your battery is draining faster than expected

If your battery life seems shorter than usual, a quick and easy step is to reboot your phone, especially if you haven't turned it off in longer than a week.

1. Press and hold the Power button.
2. Touch **Restart**.
3. Plug your phone in and charge it normally.

Tip: You can adjust settings to [extend your battery life](#).

Bluetooth problems

If you're having problems with a Bluetooth device, try these troubleshooting steps.

Bluetooth turning on automatically

Some third-party apps that control Bluetooth devices (smart watches, fitness and vehicle monitors, etc.) automatically turn Bluetooth on. If they do, this can prevent you from turning Bluetooth off.

To check if a third-party app you installed is automatically turning Bluetooth on, use [safe mode](#) to identify the problematic app, then uninstall it.

Can't pair

After each step, check to see if your issue is fixed:

1. First, [check the basics](#).
2. Make sure the phone and Bluetooth device are in discovery mode.
3. Refresh the available devices list:
 1. Go to **Settings** > **Connected devices**.
 2. Touch **Pair new device**.
4. Check if a [software update](#) is available for your phone.
5. If you're having trouble pairing with your car, see the car manufacturer's instructions for your model.
6. [Reset](#) the phone's connections, then power cycle the phone.

Can't reconnect previously paired device

Unpair the Bluetooth device, then pair it again:

1. Go to **Settings** > **Connected devices** > **Previously connected devices**.
2. Next to the paired device, touch  > **Forget**.
3. [Pair the device](#) again.

Can't hear music

After each step, check to see if your issue is fixed:

1. First, [check the basics](#).
2. Check that the volume is up on your phone and car or Bluetooth device.
3. Check that other devices paired with your phone aren't playing the music.

4. Check that **Media audio** is on:
 1. Go to **Settings** and touch **Bluetooth**.
 2. Next to the paired device, touch .
 3. Make sure **Media audio** is checked.
5. If the problem is with a car, check the car's instructions.

Can't make or hear on calls

After each step, check to see if your issue is fixed:

1. Check that other devices paired with your phone aren't getting your calls.
2. Check that **Phone audio** is on:
 1. Go to **Settings** and touch **Bluetooth**.
 2. Next to the paired device, touch .
 3. Make sure **Phone audio** is checked.
3. If the problem is with a car, check the car's instructions.

Connection drops

After each step, check to see if your issue is fixed:

1. Check battery level on your phone and on the Bluetooth device and charge if needed. Bluetooth devices may disconnect or create noise when the phone or Bluetooth battery is low.
2. Adjust positioning:
 - Make sure you are wearing or positioning the device appropriately.
 - Keep metal objects, such as keys or coins, away from the phone and device to avoid interference.
3. Clear data for this system app:
 1. Go to **Settings** > **Apps & notifications**, then touch **>**.
 2. Touch  > **Show system**.
 3. Touch **Bluetooth** > **Storage** > **Clear storage**.

Paired device can't see contacts

Check that contact sharing is on:

1. Go to **Settings** > **Connected devices**.

2. Next to the paired device, touch .
3. Make sure **Contact sharing** is on.
4. Check and adjust sharing settings on the paired device or in the device's app.

Fix it: Check the basics

After each step, see if your issue is fixed:

1. Check battery level on your phone and Bluetooth device, and charge if either is low.
2. Keep the phone and Bluetooth device within 30 feet of each other, closer for better performance.
3. On your phone, turn Bluetooth off and then on again.
4. Turn off the Bluetooth device to disconnect it. Then turn it back on to automatically [reconnect](#) with the phone.
5. Power cycle both your phone and the Bluetooth device.

If that doesn't fix it, follow the steps for specific problems in the sections above.

Wi-Fi problems

After each troubleshooting step, check to see if the issue is fixed.

Can't connect to a network

1. When you [enter the password](#) to connect:
 - Get the password from the Wi-Fi router and make sure you enter it correctly on your phone.
 - If the **CONNECT** button is greyed out, the password you entered isn't long enough. Confirm the router's password and re-enter it on your phone.
2. Check if a [software update](#) is available for your phone.
3. Check that the Wi-Fi router firmware is up to date.
4. [Reset](#) the phone's network connections.
5. [Reset](#) the phone.

Connection drops

After each troubleshooting step, check to see if the issue is fixed.

1. Turn off [Wi-Fi scanning](#).

2. Set Wi-Fi to [always remain connected](#), even when the phone sleeps.
3. [Forget](#) the network connection. Then [set up](#) the Wi-Fi connection again.
4. Check if a [software update](#) is available for your phone.
5. Restart your wireless router by unplugging it from the power outlet for about 30 seconds and then plugging it back in. Once the wireless router is running again, try to reconnect.
6. On a computer, log into your router and try adjusting one or more of these router settings:
 - If the router has multiple bands, disable the lower band.
 - Change the encryption/security setting of the SSID from WPA-password to WPA-PSK.
 - Don't use automatic channel selection. Instead, assign a fixed channel, such as Channel 6.
7. [Reset](#) the phone's connections.

Hotspot problems

If you can't connect a computer or tablet to your phone's Wi-Fi [hotspot](#):

1. The cellular network for your phone may not be in range. Check the signal icon in your status bar to ensure you have strong connection. If not, try these [troubleshooting steps](#).
2. Re-enter the password on the device to match the [hotspot password](#) set up on your phone. Make sure that the encryption type and security settings match on the device and your phone.
3. Disconnect and then reconnect:
 1. Turn off the connection from your device.
 2. Turn off the phone's hotspot.
 3. Restart your device.
 4. Wait for 1 minute, then turn on and [enable](#) the hotspot on your phone.
 5. Reconnect the device.

If you've connected a computer or tablet but can't access certain web sites:

1. Power cycle your computer or tablet.
2. Make sure the browser version is up to date.

Can't transfer files or connect to computer

If you're having problems using a [USB connection](#) to connect your phone to your computer, try these troubleshooting steps.

Check your computer

Windows computer

1. Check your computer's settings to make sure that Windows automatically detects new hardware.
2. Restart your computer.

Mac computer

- Check that your computer is running Mac OS X 10.5 and up.
- Check that your computer has [Android File Transfer](#) installed and open.
- Restart your computer.

Check your phone

1. Check if a [software update](#) is available for your phone.
2. Hold down your phone's Power button for 5-7 seconds, or up to 30 seconds.

Check your USB connection

1. Try a different USB cable. Not all USB cables can transfer files.
2. To test the USB port on your phone, connect your phone to a different computer.
3. To test the USB port on your computer, connect a different device to your computer.

Forgot unlock code

If you've forgotten your PIN, pattern, or password for unlocking your screen, you'll need to erase your phone, set it up again, and set a [new screen lock](#).

1. Make sure you know your Gmail address and password, which you'll need when setting up the phone. If you've forgotten them, use Google's [website](#) to retrieve them.
2. Perform an external reset of your phone. [Learn how](#).

Can't sign in to Google

If you've forgotten the Gmail address and password for your Google account:

1. Visit [Google's website](#) to reset the password.
2. On a computer, log in to Gmail and confirm that the new password works.
3. Wait 24 hours after changing your password before resetting your device. For security, you can't use an account to set up a phone after reset if that password changed within 24 hours.

Account sync issues

If your account is having problems syncing, you may see a message or an  icon.

In most cases, these issues are temporary and your account will sync again after a few minutes. If you keep having sync issues, try the solutions below.

Sync account manually

1. Go to [Settings](#) > **Accounts**.
2. Touch the account to sync.
3. Touch **Account sync**.

If your phone syncs, your issue is fixed. If not, try the troubleshooting solutions below.

Basic troubleshooting

After each troubleshooting step, try manually syncing to test if sync works.

1. Check that auto-sync is on.
 1. Go to [Settings](#) > **Accounts**.
 2. Touch the account.

↻ by the account name means that some or all of the account's information is configured to auto-sync.

🚫 by the account name means that the account will not auto-sync.

2. Make sure your Internet connection works.

For sync to work, you need an Internet connection. To test if your connection is working, open a browser and load a website. If the website doesn't load, get help connecting to [Wi-Fi](#) or to [cellular data](#).

3. Check if you have account issues.

For sync to work, you need to be able to sign in to your Google account. Make sure that you can sign in to your account in other ways and on another device. For example, try checking your Gmail with your computer's browser.

- If you can sign in, the issue is with your phone. You can move on to the next solution.
- If you can't sign in, [your account may have an issue](#).

4. Check if a [software update](#) is available for your phone.

Advanced troubleshooting

After each troubleshooting step, try manually syncing to test if sync works.

1. [Remove and re-add](#) your account.
2. Clear cache and data for the Contacts app.
 1. If you've saved any contacts since you last synced, back them up. Open the **Contacts** app and touch ≡ > **Settings** > **Export**, then export to a VCF file and email the file to yourself.
 2. Clear the [cache and data](#) for the Contacts app.
 3. Download the VCF file that you emailed to yourself, then import those contacts (**Contacts** > ≡ > **Settings** > **Import**).

App or widget problems

App or widget missing from home screen

If a widget disappeared from your [home screen](#), then [add the widget](#) by touching & holding an empty spot on your home screen.

If an app disappeared from your home screen, the shortcut for opening the app was removed and you just need to [add a shortcut](#).

If an app disappeared from your list of all apps, you need to [reinstall](#) it.

Where are my icons?

If you're using the  navigation bar, the  icons are hidden. To restore these icons, [turn off](#) the navigation bar.

App crashes, won't open, or isn't working

After each step, check to see if the issue is fixed:

1. Turn your phone off and then on again.
Press and hold the Power button, then touch **Power off**.
2. Check that you have not disabled permissions for the app. If any permissions are turned off, [turn them on](#) and try using the app again.
3. [Update the app](#).
4. [Force stop the app](#). This completely shuts down the app, including any background services that may be causing your issue.
5. [Clear the app's cache](#). This frees up space by removing temporary files.
6. [Clear the app's data](#). This erases all data saved in this app.
7. Contact the app's developer.
 1. [Open](#) the Play Store app.
 2. Touch  > **My apps & games**.
 3. Touch the app and swipe down to see contact information.
8. If all else fails, [delete the app](#).

Tip: To figure out which third-party app is causing performance problems, [use safe mode](#).

App disabled in safe mode

If apps are disabled because you're in [safe mode](#), you can't use them until you exit safe mode.

To exit safe mode, turn your phone off and then on again.

Problems with Play Store



For help with Play Store, read [Google's troubleshooting information](#).

Problems with Gmail

For help with Gmail, read [Google's troubleshooting information](#).

Problems with app you installed

After each step, check to see if the issue is fixed:

1. Check for [updates](#) to the app.
2. If you can open the app, touch  or  > **Help** and look for troubleshooting information.
3. [Clear the app's cache](#).
4. Go to the developer's website for support.
 1. [Open](#) the Play Store app.
 2. Touch  > **My apps & games**.
 3. Touch the app and swipe down to see a link to the website.

Messaging problems

If you're having problems [sending or receiving](#) messages, try the following:

1. Check for [updates](#) to your messaging app.
2. Check if a [software update](#) is available for your phone.
3. Turn your phone off and then on again.
4. If the problem persists, follow the steps below for specific problems. After each troubleshooting step, check to see if your issue is fixed.

Red ! on text message

If you see , your text message was not sent.

1. Check your signal strength:

- Weak signal from your cellular provider is a common cause of unsent messages. In the [status bar](#), see how many bars your network connection has. If you see only one or two bars, change locations to improve your signal strength, particularly if you are indoors.
2. Open the conversation and [resend](#) the message.

Can't hear notifications

Adjust your [notification settings](#).



Can't send or receive messages

1. Change your preferred network to **Global**.
2. If you recently switched from iPhone and are having trouble sending messages to or receiving them from an iPhone, your phone number may still be associated with iMessaging. You need to [deregister your account](#).
3. Contact your carrier.

Can't send or receive pictures or videos

Your data plan must support MMS (multimedia messaging) and [cellular data must be on](#).

Messages app stopped

1. Check that you have not disabled permissions for the Messages app. If any permissions are turned off, [turn them on](#) and try using the app again.
2. [Force stop the app](#). This completely shuts down the app, including any background services that may be causing your issue.
3. Uninstall any recent app updates.
Touch & hold , then touch  **App info** >  > **Uninstall updates**.
4. [Clear the app's cache](#). This frees up space by removing temporary files.
5. [Reset](#) the phone.



Keyboard not working

If your keyboard has problems, like a missing spacebar:

1. Check for [updates](#) to your keyboard app.
2. Turn your phone off and then on again.
3. Clear the [cache](#) for the keyboard app.

Problems with Facebook, WhatsApp, other apps

If you're having problems with messaging apps that you installed:

1. Check for [updates](#) to the app.
2. If you can open the app, touch  or  > **Help** and look for troubleshooting information.
3. Turn your phone off and then on again.
4. [Clear the app's cache](#).

Camera problems

Photo looks blurry

Wipe the lens clean with a soft, dry cloth and retake the photo.

If new photos still look blurry:

- Increase resolution (photo size) in the Camera app. A smaller photo size results in lower image quality.
- Avoid zooming when taking a photo. Pixelation always occurs when you zoom a digital photo. If you use zoom during the shot itself, pixelation will be more evident.
- If you're indoors and taking a panoramic photo, switch to regular mode. Panorama works best for outdoor shots; the algorithm that stitches the images together isn't optimized for indoor, up-close shots.

Accidentally deleted photos

You can try to [recover](#) recently deleted photos.

If recovered, be sure to [back up your photos](#) to the cloud.

Can't delete photo

If a photo or video you deleted comes back, check if it's on your SD card. To delete it, use the Files app. (If you don't have this app, [download](#) a file manager app and use it to delete the photo from your card.)

Or, [remove](#) your card from the phone and use a computer to delete photos from the card.

Error: Please restart camera

After each troubleshooting step, check to see if the issue is fixed:

1. Turn your phone off and then on again.

2. Clear the [cache](#) for the Camera app.
3. [Check for updates](#) to your Camera app.
4. Use [safe mode](#) to see if apps you installed are causing the issue and uninstall as needed.
If the camera works correctly in safe mode, a third-party app is probably causing the issue.
5. If you're storing photos/videos on your SD card, [remove](#) the card and see if you can take photos without getting the error. If so, replace the SD card with a new card. Make sure the new card is certified A1 and has a fast write speed.

Error: Camera busy

This error can occur if you use the camera in one app and then switch to another app that requires permission to access the camera.

After each troubleshooting step, check to see if the issue is fixed:

1. Turn your phone off and then on again.
2. Check which apps have [permission](#) to access the camera.



[Settings](#) > **Apps & notifications** > **App permissions** > **Camera**

Review the list of the apps on your phone that request camera access and remove access for apps that look suspicious or that you don't use.

3. Clear the [cache and data](#) for the Camera app.

Error: Trash is full

If you're getting messages about the trash being full:

1. [Open](#) the **Photos** app.
2. Touch  > **Trash**.
3. Touch  > **Empty trash**.

Update Android software

For best performance, keep your phone updated with the latest available Android software.

Check Android version number

To check what version of Android your phone is running:

1. Go to [Settings](#) > **System** > **About phone** > **Android version**.
2. The number displayed is your phone's Android version.

Get Android software updates

Your phone notifies you if an Android software update is available.

To manually check for updates, go to [Settings](#) > **System** > **System updates**.

If an upgrade is available, follow the onscreen instructions to install it.

Tip: To save data charges, use a [Wi-Fi connection](#) to download software updates.

You can't downgrade to a previous software version after installing an update.

Timing for Android software updates

For the latest update plans, see the [software update](#) website for your country. Our support agents get their Android update information from here too. If the website doesn't have a update release date for your phone, then we don't know the release date yet.

We deliver Android updates from Google to you as soon as possible, but with several phone models, regions, and distribution channels we may have hundreds of software versions to test before releasing an Android software update to your phone. Because dependencies on carriers and other key partners for certifications, independent testing, and requests for changes take more time, all phone owners don't receive updates at the same time, even in the same region.

Reset Wi-Fi, cellular data, and Bluetooth

If you're having problems with connections, review this information first:

- [Wi-Fi](#)
- [Bluetooth](#)
- [Cellular data](#)
- [Hotspot](#) (internet sharing)

Then, if you're still experiencing problems, try resetting all network settings:

1. Go to **Settings** > **System** > **Advanced** > **Reset options**.
2. Touch **Reset Wi-Fi, mobile & Bluetooth** > **Reset settings**.
3. If you're using dual SIMs, select the SIM to reset for mobile data settings.
4. Touch **Reset settings**.
5. Try to reconnect to Wi-Fi, cellular data, and Bluetooth, or try to share your internet connection again.

Reset phone

What a reset does

Resetting your phone erases all data and brings it back to out-of-the-box condition. This data will be erased from the phone:

- [Google account](#)
- Media (music, photos, videos)
- System settings and data
- App settings and data (including text messages)
- Downloaded apps

Before you reset

1. Back up your data.

If your phone works and you can unlock it, be sure to:

- Copy your photos, videos, and music [to a computer](#) or to [cloud storage](#).
- Make sure that any changes you made to contacts or calendar are [synced](#) to an account.

2. Know your Google credentials.

If you added your Google account to your phone, make sure you know the Gmail address and password for that account. To help prevent others from using your phone without permission, after you reset a phone, you can't set up the phone until you enter your Google account information again. If you've forgotten the password, you can [reset](#) it.

Reset phone from Settings

To erase all data and reset your phone:

1. Go to **Settings** > **System** > **Advanced** > **Backup**.

2. If you're resetting because you suspect a third-party app is causing problems, turn off **Back up to Google Drive**. Instead of automatically restoring apps after the reset, you'll want to [restore them one at a time](#) to determine which is causing the problem.
3. Touch ◀, then touch **Advanced > Reset options > Erase all data (factory reset)**.

External reset

If you can't access [Settings](#) , do an external reset.

Everything will be deleted from your phone. However, if you personalized your wallpaper or startup message at the time of purchase, you can preserve the personalized content shipped with your phone.

1. Make sure your battery is charged at least 30%.
2. Turn off the phone.
3. Press and hold the Volume Down button and the Power button at the same time until the phone turns on.
4. Press the Volume Down button until you see Recovery mode.
5. Press the Power button to restart in Recovery mode.
6. If you see an Android robot with a red exclamation mark, press and hold the Power button, then press and release the Volume Up button to display the menu options.
7. Use the Volume buttons to scroll to **Wipe data/factory reset**, then press the Power button to select it.
8. Use Volume buttons to scroll to **Yes**, then press the Power button to select it.
9. Use Volume buttons to scroll to an option and press the Power button to select it:
 - **Userdata only**: preserves personalized content shipped with your phone, including power up message, image, wallpaper, and ringtones
 - **Userdata + personalized content**: deletes all content and data

Allow several seconds for the reset to complete.

10. Use Volume buttons to scroll to **Reboot system now**, then press the Power button to select it.



Allow several minutes for the reboot to complete. If the phone doesn't finish rebooting, press & hold the Power button until the screen turns dark, then release it to power up normally.

11. If you reset your phone because you suspect a third-party app is causing problems, when you set up the phone again, be sure you don't copy all apps. Then, [restore](#) one app at a time and use the phone for a while. If the phone has no issues, install the next app and retest.

Get more help

Use  above to search for answers to your question.

If you don't find the information you need there, then try these resources.

Issue	Where to get help
Billing or cellular network issues	Contact your carrier.
Learn to use an app	Open the app and touch  or  > Help .
Phone issue	Visit mobilesupport.lenovo.com for solutions, user forums, live contact options.
